



2000.1D EVO
Owner's Manual

English

Dear Customer,

Congratulations on acquiring your **SoundDigital!** You've just purchased a product of high quality and technology. The **SoundDigital** products are developed to assure maximum efficiency and reliability to your sound system.

Class D Amplifiers:

The main characteristics of Class D amplifiers are: audio quality, efficiency, versatility and compact design. Here are the advantages of these characteristics:

Audio Quality – Class D amplifiers used to have a limited response in the past and they used to have a worse performance regarding higher frequencies than Class AB amps, despite being more efficient. Introducing new technologies, **SoundDigital** developed a Class D amplifier superior to the Class AB ones in efficiency and performance.

Efficiency – The **SoundDigital** Class D amplifiers have a total efficiency (Power Source + Output) higher than 70%, assuring a battery consumption and a heating lower than the expected.

Versatility of Uses –The flat response of all the frequencies of **SoundDigital** amplifiers allows them to be used in all the kinds of systems: SPL, Sound Quality, and Pancadao, meeting the needs with extreme quality.

Compact Design – The high efficiency and technology allow our amplifiers to be really compact, making it easy to install them in vehicles where you have limited space.

IMPORTANT INFO

Read this manual and follow its instructions and information carefully. It contains extremely important information to have your amplifier working properly. If you feel the need to contact our Tech Support, you can reach our technicians through the e-mail info@sounddigitalusa.com.

We recommended the use of **SoundDigital** original accessories for better performance. The crossovers, power supplies and voltmeters offered by **SoundDigital** follow the same quality standards as our amplifiers, assuring an excellent quality and high power sound system to our customers.

To know our complete line of amplifiers and accessories, visit www.sounddigitalusa.com.



Warning!

This “Warning” sign alerts the user of important info. Not following this instructions may cause injuries to the user or damage to the equipment.

- ▶ To prevent personal injuries or damage to the amplifier, read all the safety instructions written on this manual;
- ▶ If you have questions about the installation of this equipment, get in touch with our tech support or with a professional specialized in car audio installation;
- ▶ Before proceeding with the installation of any electric equipment on your vehicle, unplug the negative (-) terminal of the battery to avoid fires, injuries or damages;
- ▶ Use your sound system safely, exposure to continuous sound pressure over 85 dB may cause irreversible hearing loss.

ADDITIONAL INFORMATION

PACKAGE CONTENTS

- 1 2000.1D EVO Amplifier
- 1 Owner's Manual
- 1 Allen Wrench 2.5mm
- 1 Allen Wrench 4mm
- 1 Promotional Sticker

CONTACT CHANNEL

Customer Service

+1 786-600-1056
info@sounddigitalusa.com

Tech Support

info@sounddigitalusa.com

Website

sounddigitalusa.com

Social Media

facebook.com/sounddigitalusa

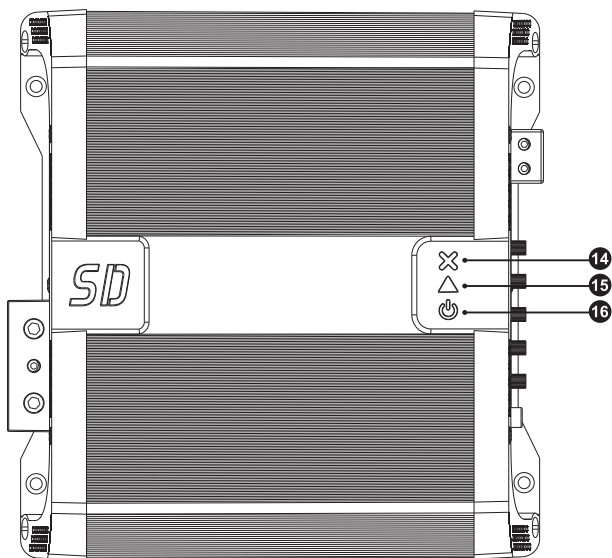
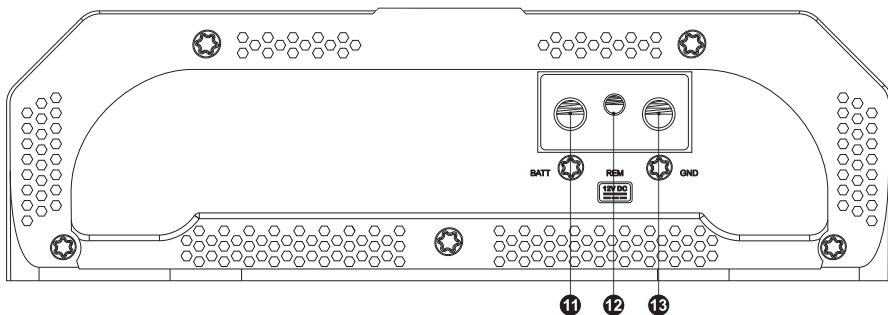
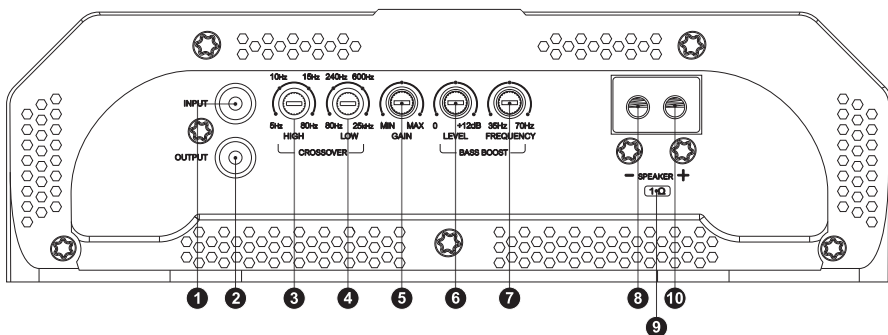

PANELS DESCRIPTION

- 01 Audio Input RCA connector;
- 02 Audio Output RCA connector;
- 03 Variable high pass filter control (5Hz ~ 80Hz);
- 04 Variable low pass filter control (80Hz ~ 25kHz);
- 05 Variable signal gain control;
- 06 Variable bass boost control (0dB ~ +12dB);
- 07 Variable bass reinforcement frequency control (35Hz ~ 70Hz);
- 08 Negative speaker connector (-);
- 09 Minimum output impedance;
- 10 Positive audio output connector (+);
- 11 Positive power supply connector (+12V);
- 12 Remote power supply connector (REM);
- 13 Negative power supply connector (GND);
- 14 "Protection" LED indicator (Red);
- 15 "CLIP" LED indicator (Yellow);
- 16 "Power On" LED indicator (Blue).



Declaration of Conformity

CE

J. Anfor Eletrônicos - ME
Gravatá - RS
Brazil

Declare in own responsibility that the products described in this owner's manual are in compliance with technical standards:

- EN 60065:2002+A1:2002+A11:2008+A2:2010+A12:2010

- IEC 60065:2014-06

Juliano Anfor
J. Anfor Eletrônicos
Brazil

Electrical Dimensioning

For proper operation of your amplifier your **SoundDigital** amplifier needs the correct size of cables and electrical system.



The protection fuse or circuit breaker must be installed at a max distance of 30 cm (1 foot) from the battery.

Warning!

Minimum capacity of the battery	120Ah
Recommend capacity of the battery	240Ah
Fuse/circuit breaker size	125A
Size of recommended cable	3 AWG/25mm ²

Use good quality cables (copper if possible) for the connections to the amplifier. CCAW cables should be double the size (see table above).



Unplug the negative (-) terminal of the battery before proceeding with any electrical installation in the vehicle to avoid fire starts, wounds or damage to the amplifier.

Warning!

Installation Tips

- ▶ The ground cable should be the shortest possible and should be connected to the chassis of the vehicle. The surface should be sanded at the contact point to create a clean, metal-to-metal connection between the chassis and the termination of the ground wire.

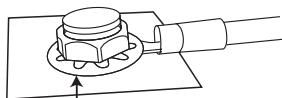

Remove the paint between the terminal and chassis.

- ▶ Keep the RCA cables together, but away from the power or the audio output cables and away from electric equipment such as electronic fuel injection centrals, electric engines, etc.



You should never connect or disconnect RCA cables with the amplifier on, because it may damage the headunit or the amplifier.

Warning!

- ▶ When passing cables through metallic walls, use rubber grommets to avoid damage to the cable and short circuits.
- ▶ Choose a proper place to install the amplifier and avoid blocking the side ventilation panels.

- ▶ Securely mount the amplifier so that it does not come loose in the event of a collision or a sudden jolt to the vehicle. Avoid mounting it on metallic parts of the vehicle, because it may cause an earth loop (you might have noise issues).



Be careful when drilling holes in the vehicle. Verify if you're not drilling holes in the fuel tank, brake lines or electrical cables of the vehicle.

Warning!

Use speakers accordingly to the power and impedance of the amplifier. Verify if the adjustment filters can be used to increase the performance of the equipment.



Never use speakers with impedance under the nominal impedance of the amplifier or you may damage it.

Warning!

The **SoundDigital** amplifiers are micro controlled and have an electronic monitoring of all of their functions, offering usefull information to the user through their LED's.

Blue LED

- When constantly on, indicates the amplifier is working.
- When the audio is cut off and it blinks 10 times, it indicates the electric tension is under 8.9V or over 16V.

Red LED

- When it blinks during the audio reproduction, it indicates the input tension is under 9.5V.
- When the audio is cut off and the LED is constantly on, it indicates the amplifier is in protections due to high temperature. Turn the amplifier off until it gets to its working temperature.
- When the audio is cut off an the LED blinks, it means it is defective and must be sent to one of our technical repair centers.

Yellow LED

- During the audio reproduction, it makes the sound distortion monitoring. When it turns on, the speakers are received distorted signal. So, you should turn down the amplifier's gain or the headunit volume.
- If the audio is shut off and the LED blinks 10 times, it indicates short circuit or low impedance on audio output terminals.

Blue LED and Yellow LED

- When the audio is cut off and the Blue LED and Yellow LED constantly on, it means it is defective and must be sent to one of our technical repair centers.

Unplug the negative (-) terminal of the battery before proceeding with any electrical installation in the vehicle to avoid fire starts, wounds or damage to the amplifier.

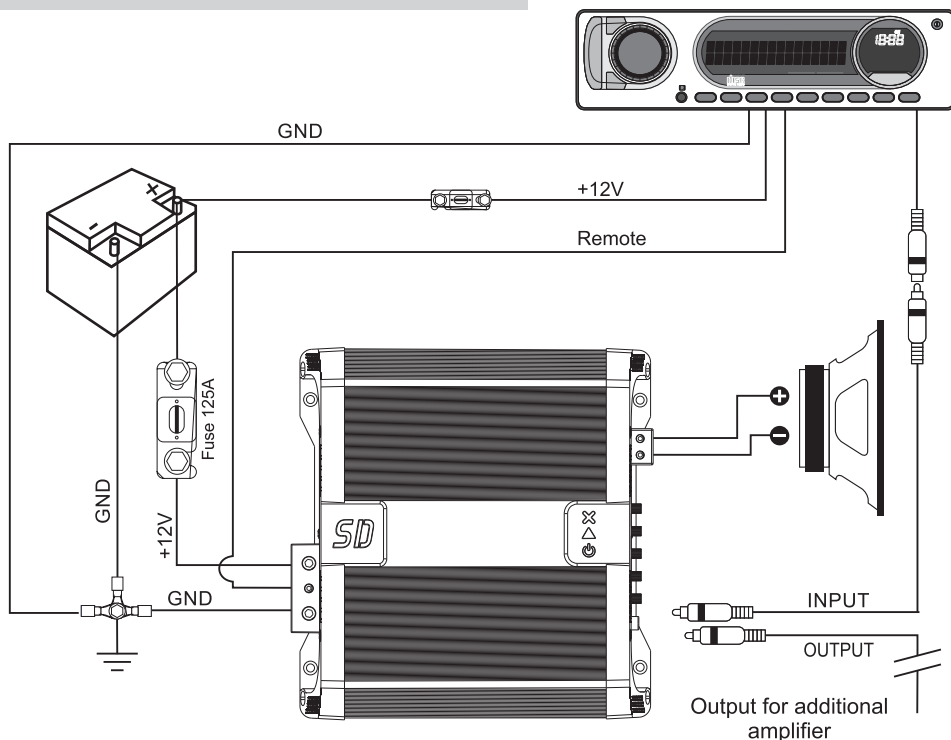

- ▶ To avoid unwanted noise in the system, join the ground points of the equipment and audio output to only one point.
- ▶ After the end of the electrical installation, connect the negative cable of the battery and, before starting the audio system, check if all connections are correctly done.
- ▶ In order to adjust the gain, use the headunit volume in 70% of its total, play a musical program of your preference and turn up the gain until the "CLIP" LED blinks. Set the gain in a position where the "CLIP" LED doesn't blink.
- ▶ Some headunits with strong signal output may reach max power even when the gain is next to its minimum. In that case, limit the volume of the headunit right before the point where the "CLIP" LED starts blinking.



Warning!

Gain positioning over the correct spot may cause noise, trigger protection state or damage to the speakers.

- ▶ If you need to increase the bass response, adjust the frequency and gain of the Bass Boost according to your preference. Make sure the "CLIP" LED does not blink with the new setting.
- ▶ Adjust the Low and High pass filters according to your preference and needs of the speakers. If you have any doubts, talk to the speaker's manufacture.

RMS Power	2000.1D EVO 1 Ω			2000.1D EVO 2 Ω		
Impedance	1 Ω	2 Ω	4 Ω	2 Ω	4 Ω	8 Ω
Power @ 12.6V	2000W	1100W	605W	2000W	1100W	605W
Power @ 14.4V	2612W	1437W	790W	2612W	1437W	790W

Input Signal and Filters	
Input Sensivity	0.5V ~ 8V
High Pass Filter	5Hz ~ 80Hz
Low Pass Filter	80Hz ~ 25kHz
Bass Boost	0 ~ +12dB
Bass Boost Frequency	35Hz ~ 70Hz

Power Supply	
Operating Voltage	9V ~ 16V
Max Current Draw	220A
Current Draw (Music)	110A
Total Efficiency (Source + Output)	72%

Audio Specs	
SNR (LPF 15kHz / Nominal Power)	90dB
THD + N (Nominal Impedance / 100Hz / LPF 15kHz / Nominal Power)	0.1%
THD + N (Nominal Impedance / 100Hz / LPF 15kHz / 50% of Rated Power)	0.06%
THD + N (Nominal Impedance / 100Hz / LPF 15kHz / 10% of Rated Power)	0.05%
Frequency Response (-1dB)	10Hz ~ 20kHz
Frequency Response (-3dB)	5Hz ~ 25kHz
Damping Factor (Nominal Impedance @100Hz)	>1000

Graphics

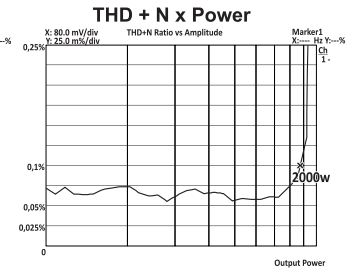
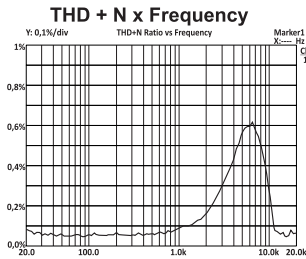
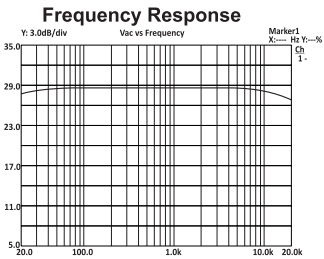

Dimension

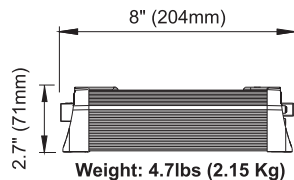
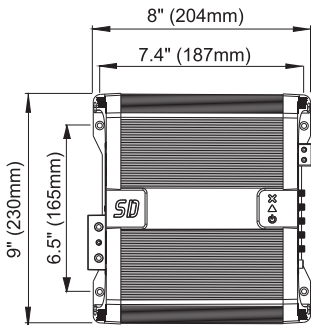

LIMITED WARRANTY

SounDigital warrants the original purchaser that this product shall be free of defects in materials and workmanship for a period of twelve (12) months from the original date of purchase. Some countries have extended warranty in case the product is installed by an authorized dealer. This warranty is not transferrable and applies only to the original customer from an authorized SounDigital dealer.

Warranty is void when:

- Defect or problem caused by misuse of the product;
- Incorrect installation or non-conformity with the Manual;
- Maintenance made by unauthorized personnel;
- Alteration or removal of the seal/serial number;
- Exposure to adverse conditions (weather, humidity, etc);
- Damage caused by fall, impact or natural depreciation, caused by transport and/or handling, risks, or smashings;
- Products purchased more than 12 months ago.

Warranty covers:

- Component or material with manufacturing defects;
- Workmanship/service needed to repair the equipment;
- If you need service on your SounDigital amplifier, send it (freight-prepaid) to SounDigital's Amplifier Repair Center through an authorized SounDigital dealer (must be accompanied by proof of purchase);
- Any extra information you can get by contacting us at the e-mail address: info@sounddigitalusa.com;
- In case of manufacturing defect or bad quality of raw material, the max compensation will be the replacement of the product, not allowing any kind of compensation payment;
- New modifications/iterations on a product don't obligate the manufacturer to modify products formerly produced.



www.sounddigital.com.br
www.sounddigitalusa.com



+ 55 51 3042-9001
+ 1 786-600-1056



/SounDigitalBrasil
/SounDigitalUSA



@sounddigital
@sounddigitalUSA