



400.2D EVO

400.4D EVO

800.4D EVO

400.4S EVO

800.4S EVO

Owner's Manual

PACKAGE CONTENTS

1 EVO Amplifier

1 Owner's Manual

1 Allen wrench 2.5mm*

2 Cables for High Input

1 Promotional Sticker

*Only in "S" version

Dear Customer,

Congratulations on acquiring a product with the highest quality and technology!

The **SoundDigital** products are developed to assure maximum efficiency and reliability to your sound system.

Class D Amplifiers:

The main characteristics of Class D amplifiers are: audio quality, efficiency, versatility and compact design. Here are the advantages of these characteristics:

Audio Quality – Class D amplifiers used to have a limited response in the past and they used to have a worse performance regarding higher frequencies than Class AB amps, despite being more efficient. Introducing new technologies, **SoundDigital** developed a Class D amplifier superior to the Class AB ones in efficiency and performance.

Efficiency – The **SoundDigital** Class D amplifiers have a total efficiency (power source + output) higher than 60%, assuring a battery consumption and a heating lower than the expected.

Versatility of Uses – The flat response of all the frequencies of **SoundDigital** amplifiers allows them to be used in all the kinds of systems: SPL, Sound Quality, Trio Eletrico and Pancadao, meeting the needs with extreme quality.

Compact Design – The high efficiency and technology allow our amplifiers to be really compact, making it easy to install them in vehicles where you have limited space.

IMPORTANT INFO

Read this manual and follow its instructions and information carefully. It contains extremely important information to have your amplifier working properly. If you feel the need to contact our Tech Support, you can reach our technicians through the e-mail info@sounddigitalusa.com.

IMPORTANT INFO

We recommend the use of **SoundDigital** original accessories for a better performance. The crossovers and voltmeters offered by **SoundDigital** follow the same quality standards as our amplifiers, assuring an excellent quality and high power sound system to our customers.

To know our complete line of amplifiers and accessories, visit www.sounddigitalusa.com.



Warning!

This “Warning” sign alerts the user of important info. Not following this instructions may cause injuries to the user or damage to the equipment.

SAFETY INSTRUCTIONS

- To prevent injuries to the user or damage to the amplifier, read all the safety instructions written on this manual;
- If you have questions about the installation of this equipment, get in touch with our tech support or with a professional specialized in car audio installation;
- Before proceeding with the installation of any electric equipment on your vehicle, unplug the negative (-) terminal of the battery to avoid fires, injuries or damages;
- Use your sound system safely, exposure to continuous sound pressure over 85dB may cause irreversible hearing loss.
- This equipment is for use in automotive DC voltage batteries, between 12.6 and 14.4 volts. Before installing the equipment, check the voltage of the batteries;
- Do not install the amplifier in places exposed to water, dirt or humidity;
- Securely mount the amplifier so that it does not come loose in the event of collision or a sudden jolt to the vehicle. Avoid mounting it on metallic parts of the vehicle, because it may cause a ground loop (you might have noise issues).

- When passing cables through metallic walls, use rubber O-rings to avoid cable cutting and short-circuits.
 - Make sure the place chosen for the installation of the amplifier will not interfere with the proper working of the vehicle;
 - Clean the amplifier periodically with a brush or dry cloth to assure the thermal efficiency of the heatsink;
 - This product may reach temperatures over 60°C/140°F. Make sure it is cold before touching it;
 - Be careful when making holes in the vehicle. Make sure you're not making holes in the fuel tank, brake lines or electrical cables of the vehicle;
 - Make sure the cables are properly fixed throughout the installation;
 - Wear gloves, safety glasses and all necessary PPE during the installation of **SoundDigital** amplifiers.
- Connect the power cables in to the amplifier, observing the polarity. Connect all the positive cables from the fuse holder or circuit breaker to the positive connector of the amplifier and all the negative power cables from the bussbar or from the batteries, to the negative connector of the amplifier;
 - Install the signal input cables in a proper way, distant from the power cables;
 - Connect the RCA to the head unit and amplifiers;
 - Install the audio output cables with the appropriate section, distant from the power and audio input cables;
 - Connect the audio output cables to the amplifiers and the acoustic boxes, observing the positive (+) and negative (-) polarities;
 - Install the remote cable with the power cables, using a section of 15AWG (1.5mm²) or thicker;
 - Connect the remote cable to the REM terminal on the amplifier and to a 12V power supply activated by a switch key or to the remote power output of the head unit;

Installation Sequence

- Before proceeding with the installation, unplug the negative from all of the batteries;
- Mount the amplifier in such a way you have access to the connectors;
- Install the power cables on the vehicle in a proper way. From the battery to the bussbar, fuse holder or circuit breaker. Choose the appropriate size for the cable (see Technical Specs Table). Make all of the connections to the bussbars, fuse holders or circuit breakers, with no fuses installed and with the circuit breakers in the "Off" position;
- Before powering the system, verify all the connections and make sure there are no mistakes or short-circuits on the power and ground cables;
- Reconnect the ground of the batteries;
- Check if the remote key is in the "Off" position and if the head unit is turned off, then place the fuses in the fuse holders or switch the circuit breakers on.



Warning! The max. distance for the installation of the fuse/circuit breaker is one foot away from the battery.

PANELS DESCRIPTION

400.2D EVO

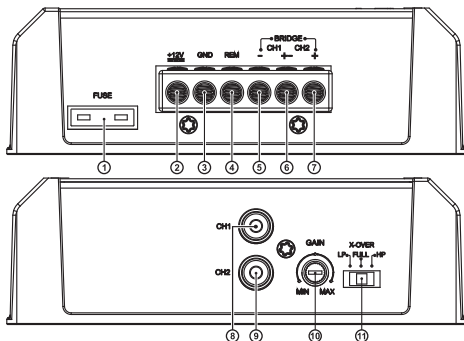

- ① Protection Fuse 30A;
- ② Positive power supply connector (+12V);
- ③ Negative power supply connector (GND);
- ④ Remote power supply connector (REM);
- ⑤ Negative speaker connector (-) CH1;
- ⑥ Positive speaker connector(+) CH1 and negative (-) CH2;
- ⑦ Positive speaker connector (+) CH2;
- ⑧ Audio input RCA connector CH1;
- ⑨ Audio input RCA connector CH2;
- ⑩ Gain control CH1 and CH2;
- ⑪ Selector switch crossover CH1 and CH2.

400.4D EVO

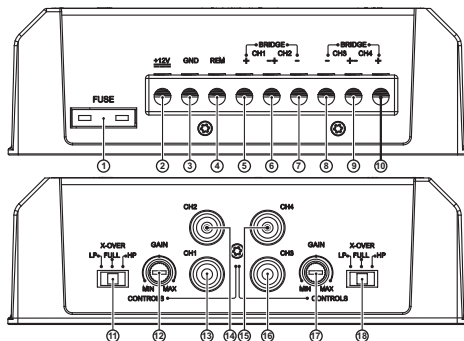

- ① Protection Fuse 30A;
- ② Positive power supply connector (+12V);
- ③ Negative power supply connector (GND);
- ④ Remote power supply connector (REM);
- ⑤ Positive speaker connector (+) CH1;
- ⑥ Negative speaker connector (-) CH1 and positive (+) CH2;
- ⑦ Negative speaker connector (-) CH2;
- ⑧ Negative speaker connector (-) CH3;
- ⑨ Positive speaker connector (+) CH3 and negative (-) CH4;
- ⑩ Positive speaker connector (+) CH4;
- ⑪ Selector switch crossover CH1 e CH2;
- ⑫ Gain control CH1 and CH2;
- ⑬ Audio input RCA connector CH1;
- ⑭ Audio input RCA connector CH2;
- ⑮ Audio input RCA connector CH4;
- ⑯ Audio input RCA connector CH3;
- ⑰ Gain Control CH3 and CH4;
- ⑱ Selector switch crossover CH3 and CH4.

PANELS DESCRIPTIONS

400.4S EVO

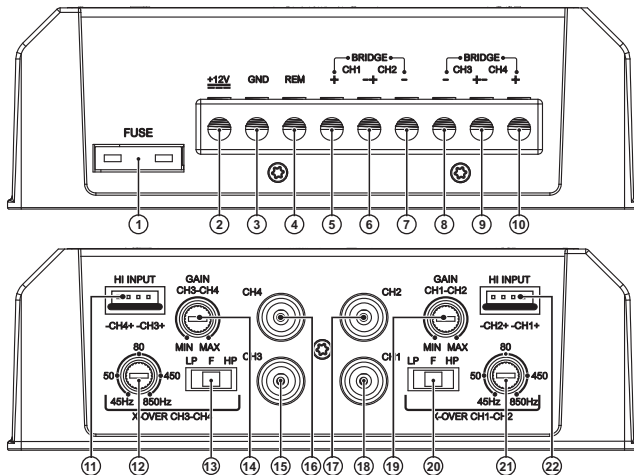

- ① Protection fuse 30A;
- ② Positive power supply connector +12V;
- ③ Negative power supply connector (GND);
- ④ Remote power supply connector (REM);
- ⑤ Positive speaker connector (+) CH1;
- ⑥ Negative Speaker connector (-) CH1 and positive (+) CH2;
- ⑦ Negative Speaker connector (-) CH2;
- ⑧ Negative Speaker connector (-) CH3;
- ⑨ Positive Speaker connector (+) CH3 and negative (-) CH4;
- ⑩ Positive Speaker connector (+) CH4;
- ⑪ High level audio input CH3 and CH4;
- ⑫ Variable crossover control CH3 and CH4;
- ⑬ Selector switch of crossover CH3 and CH4;
- ⑭ Gain Control CH3 and CH4;
- ⑮ Audio input RCA connector CH3;
- ⑯ Audio input RCA connector CH4;
- ⑰ Audio input RCA connector CH2;
- ⑱ Audio input RCA connector CH1;
- ⑲ Gain control CH1 and CH2;
- ⑳ Selector switch of crossover CH1 and CH2;;
- ㉑ Variable crossover control CH1 and CH2;
- ㉒ High level audio input CH1 and CH2.

PANELS DESCRIPTIONS

800.4D EVO

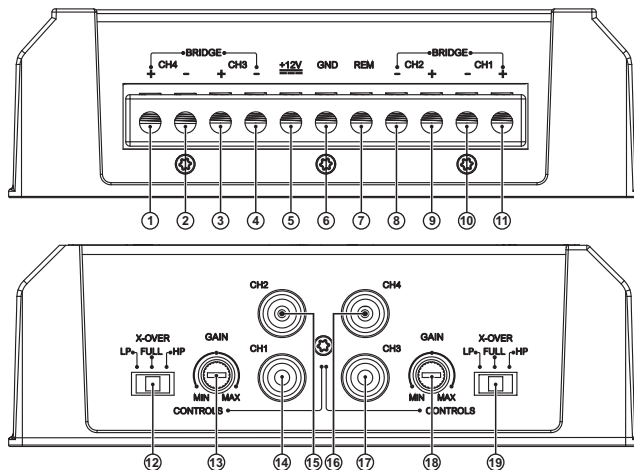

- ① Positive speaker connector (+) CH4;
- ② Negative speaker connector (-) CH4;
- ③ Positive speaker connector (+) CH3;
- ④ Negative speaker connector (-) CH3;
- ⑤ Positive power supply connector (+12V);
- ⑥ Negative power supply connector (GND);
- ⑦ Remote power supply connector (REM);
- ⑧ Negative speaker connector (-) CH2;
- ⑨ Positive speaker connector (+) CH2;
- ⑩ Negative speaker connector (-) CH1;
- ⑪ Positive speaker connector (+) CH1;
- ⑫ Selector switch of crossover CH1 and CH2;
- ⑬ Gain control CH1 and CH2;
- ⑭ Audio input RCA connector CH1;
- ⑮ Audio input RCA connector CH2;
- ⑯ Audio input RCA connector CH4;
- ⑰ Audio input RCA connector CH3;
- ⑱ Gain control CH3 and CH4;
- ⑲ Selector switch of crossover CH3 and CH4.

PANELS DESCRIPTIONS

800.4S EVO

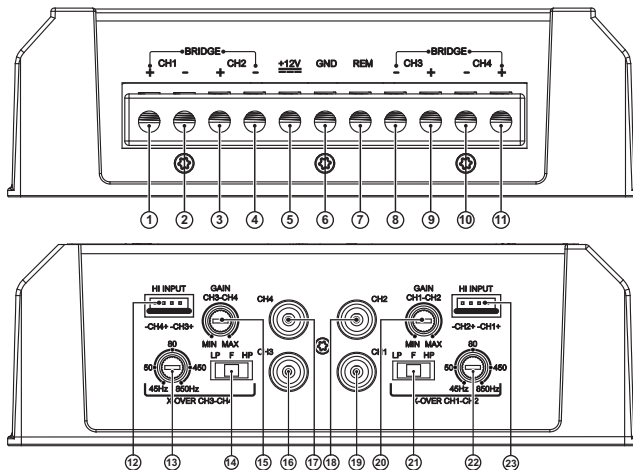

- ① Positive Speaker connector (+) CH1;
- ② Negative Speaker connector (-) CH1;
- ③ Positive speaker connector (+) CH2;
- ④ Negative Speaker connector (-) CH2;
- ⑤ Positive power supply connector +12V;
- ⑥ Negative power supply connector (GND);
- ⑦ Remote power supply connector (REM);
- ⑧ Negative Speaker connector (-) CH3;
- ⑨ Positive speaker connector (+) CH3;
- ⑩ Negative Speaker connector (-) CH4;
- ⑪ Positive speaker connector (+) CH4;

- ⑫ High level audio input CH3 and CH4;
- ⑬ Variable crossover control CH3 and CH4;
- ⑭ Selector switch of crossover CH3 and CH4;
- ⑮ Gain Control CH3 e CH4;
- ⑯ Audio input RCA connector CH3;
- ⑰ Audio input RCA connector CH4;
- ⑱ Audio input RCA connector CH1;
- ⑲ Audio input RCA connector CH2;
- ⑳ Gain Control CH1 and CH2;
- ㉑ Selector switch of crossover CH1 and CH2;
- ㉒ Variable crossover control CH1 and CH2;
- ㉓ High level audio input CH1 and CH2.

400.2D EVO INSTALLATION

ATTENTION: Before proceeding with the installation of your *SoundDigital* amplifier, unplug the negative (-) terminal of the battery.

The versatility of the *SoundDigital* multi-channel amplifiers, allows the installation in 1 or 2 channel mode.

Bellow is the schematic for the 2-channel mode:

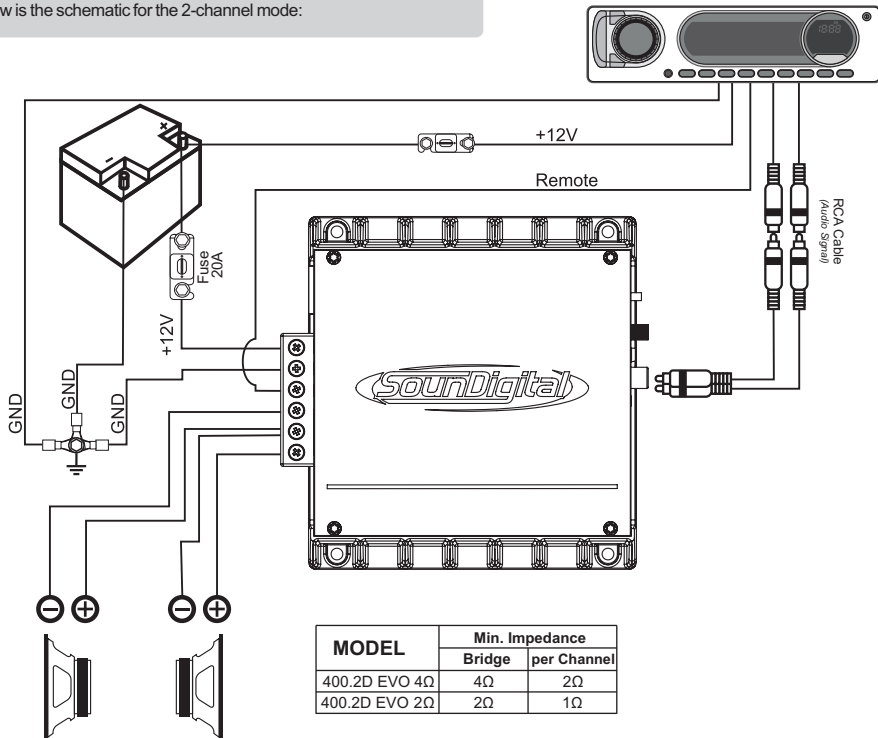

400.4D EVO / 400.4S EVO INSTALLATION

ATTENTION: Before proceeding with the installation of your *SoundDigital* amplifier, unplug the negative (-) terminal of the battery.

The versatility of the *SoundDigital* multi-channel amplifiers, allows the installation in 4, 3 or 2 channel mode.

Below is the schematic for the 4-channel mode:

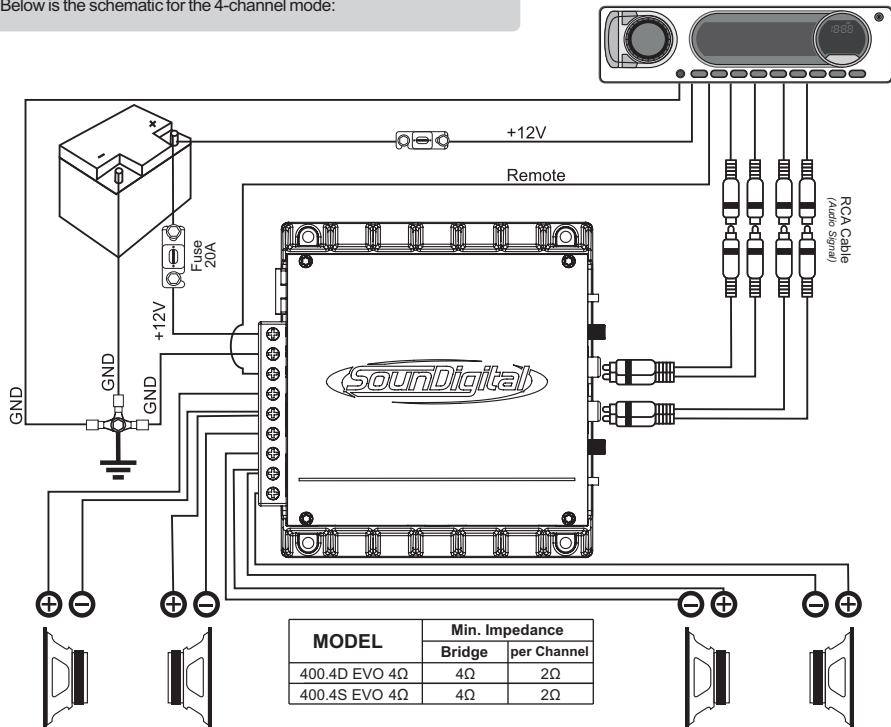

800.4D EVO / 800.4S EVO INSTALLATION

ATTENTION: Before proceeding with the installation of your *SoundDigital* amplifier, unplug the negative (-) terminal of the battery.

The versatility of the *SoundDigital* multi-channel amplifiers, allows the installation in 4, 3 or 2 channel mode.

Below is the schematic for the 3-channel mode:

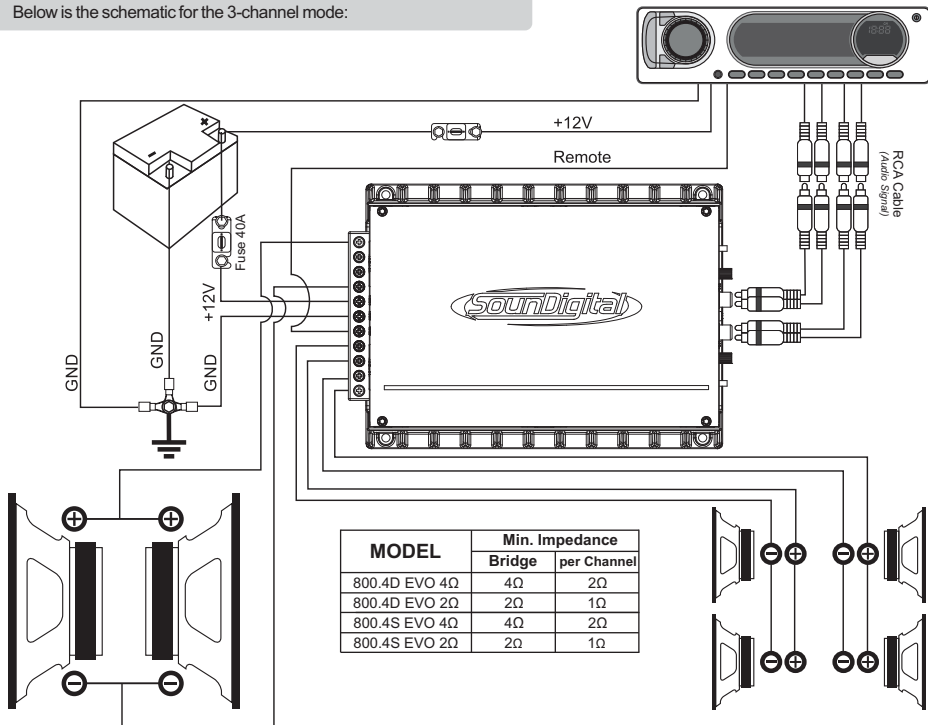

- Switch Key at position "F" (Full Range): All the frequencies are reproduced.

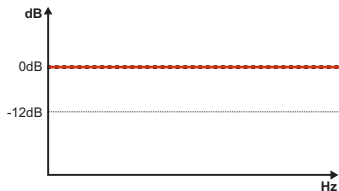

- Switch key at "HP" - Set in the variable control between 45Hz and 850Hz ("A") where you want to perform the high pass cut filter;

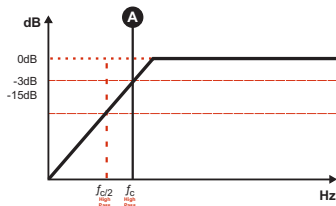

- Switch key at "LP" - Set in the variable control between 45Hz and 850Hz ("B") where you want to perform the low pass cut filter;

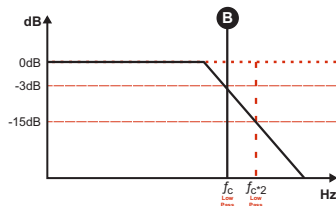

INPUT CONNECTIONS

RCA Inputs

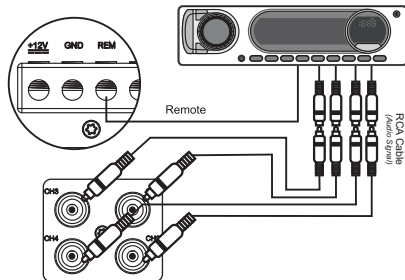

Hi Inputs (400.4S EVO and 800.4S EVO)

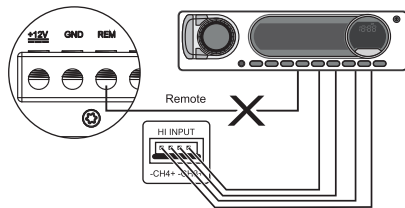

- High input must be used when the main unit does not have RCA outputs.

- When high inputs is used, no remote connection is required, the amplifier recognizes the audio signal and switches on.

- If your source unit is not able to turn on the amplifier through the high level input, the remote input should be connected normally.



Warning! RCA and hi inputs should not be used simultaneously or you may damage the amplifier.

PROCEDURES FOR SETTING THE GAIN

Necessary equipment:

- Digital AC voltmeter;
- Media with sine wave test tone (60Hz) recorded at 0db;
- Screwdriver 1/8"

Set up procedure

This procedure is the same for both gain controls;

- Turn the gain control all the way down.
- Disconnect the output cables from the amplifier outputs;
- Turn off all processing (bass, treble, loudness, EQ, etc.);
- Set the source unit volume to 3/4 of full volume.
- Set the source unit's fader control to center position;
- Set the crossover switch to "Full" or "F" and play a 60 Hz sine wave test track;
- Connect the AC voltmeter to the speaker output connectors of the amplifier. Make sure you test the voltage at the correct connectors (+ and -);
- Increase the "Input Sens." control until the target voltage is observed with the voltmeter (see the chart to the right);
- Once you have adjusted the amplifier to its correct voltage output, turn off the source unit and reconnect the speaker(s).

Model	Impedance/ Power	Bridge/ Power	Output Voltage Stereo	Output Voltage Bridge
400.2D EVO	1Ω / 200W	2Ω / 400W	14.4 V	28.2 V
400.2D EVO	2Ω / 200W	4Ω / 400W	20.0 V	40.0 V
400.4D EVO / 400.4S EVO	2Ω / 100W	4Ω / 200W	14.4 V	28.2 V
800.4D EVO / 800.4S EVO	1Ω / 200W	2Ω / 400W	14.4 V	28.2 V
800.4D EVO / 800.4S EVO	2Ω / 200W	4Ω / 400W	20.0 V	40.0 V

CROSSOVER SET UP

400.2D EVO, 400.4D EVO and 800.4D EVO

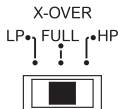

"Full" All the frequencies are reproduced;

"LP" only frequencies below 80Hz are reproduced;

"HP" only frequencies over 80Hz are reproduced.

400.4S EVO e 800.4S EVO

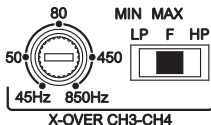

"F" All the frequencies are reproduced;

"LP" Set in the variable control on Low Pass Function;

"HP" Set in the variable control on High Pass Function.

TECHNICAL SPECS

PARAMETER	400.2D EVO 2Ω	400.2D EVO 4Ω	400.4D EVO
Bridge RMS Power @ 8Ω*	1 x 121W	1 x 220W	2 x 110W
Bridge RMS Power @ 4Ω*	1 x 220W	1 x 400W	2 x 200W
Bridge RMS Power @ 2Ω*	1 x 400W	N/A	N/A
RMS Power per channel @ 4Ω*	2 x 220W	4 x 55W	4 x 55W
RMS Power per channel @ 2Ω*	2 x 400W	4 x 100W	4 x 100W
RMS Power per channel @ 1Ω*	N/A	N/A	N/A
Frequency response (-3db)	5Hz to 20kHz	5Hz to 20kHz	5Hz to 20kHz
Crossover 12dB/oct HP	80Hz	80Hz	80Hz
Crossover 12dB/oct LP	80Hz	80Hz	80Hz
Operating voltage	9V to 16V	9V to 16V	9V to 16V
SNR	99dB	99dB	88dB
THD+N (50% Rated Power)	0.022%	0.022%	0.006%
THD+N (10% Rated Power)	0.031%	0.031%	0.009%
Input sensitivity	0.5 to 6V	0.5 to 6V	0.5 to 6V
Current draw (music)	19A	19A	20A
Max current draw (resistive load 1kHz @ 12,6V)	39A	39A	40A
Total efficiency(full power @12,6V)	81.60%	81.60%	79.00%
Damping factor	55	55	55
Gross weight	2.09lbs	2.09lbs	2.09lbs
Giftbox dimensions (LxAxP)	7" x 3.5" x 5.9"	7" x 3.5" x 5.9"	7" x 3.5" x 5.9"
Size of recommended cable (power)	8 AWG (8mm ²)	8 AWG (8mm ²)	8 AWG (8mm ²)
Size of recommended cable (output)	2 x 15 AWG (1,5mm ²)	2 x 15 AWG (1,5mm ²)	2 x 15 AWG (1,5mm ²)
Fuse/Circuit breaker (music)	20A	20A	20A
Recommended capacity of the battery	35 Ah	35 Ah	35 Ah

*Power at 12.6V @ 60Hz following the ANSI / CTA-2006B standard with a maximum THD of 1%

DIMENSIONS

400.2D EVO / 400.4D EVO / 400.4S EVO

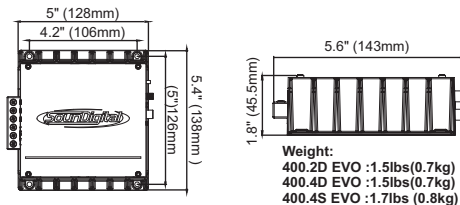

TECHNICAL SPECS

PARAMETER	800.4D EVO 2Ω	800.4D EVO 4Ω
Bridge RMS Power @ 8Ω*	2 x 120W	2 x 220W
Bridge RMS Power @ 4Ω*	2 x 220W	2 x 400W
Bridge RMS Power @ 2Ω*	2 x 400W	N/A
RMS Power per channel @ 4Ω*	4 x 60W	4 x 110W
RMS Power per channel @ 2Ω*	4 X 110W	4 X 200W
RMS Power per channel @ 1Ω*	4 x 200W	N/A
Frequency response (-3db)	5Hz to 20kHz	5Hz to 20kHz
Crossover 12dB/oct HP	80Hz	80Hz
Crossover 12dB/oct LP	80Hz	80Hz
Operating voltage	9V to 16V	9V to 16V
SNR	99dB	99dB
THD+N (50% Rated Power)	0.022%	0.022%
THD+N (10% Rated Power)	0.031%	0.031%
Input sensivity	0.5 to 6V	0.5 to 6V
Current draw (music)	39A	39A
Max current draw (resistive load 1kHz @ 12,6V)	78A	78A
Total efficiency(full power @12,6V)	81.60%	81.60%
Damping factor	55	55
Gross weight	2.97lbs	2.97lbs
Giftbox dimensions (LxAxP)	10.2" x 3.5" x 6.9"	10.2" x 3.5" x 6.9"
Size of recommended cable (power)	7 AWG (10mm ²)	7 AWG (10mm ²)
Size of recommended cable (output)	2 x 15 AWG (1.5mm ²)	2 x 15 AWG (1.5mm ²)
Fuse/Circuit breaker (music)	40A	40A
Recommended capacity of the battery	60 Ah	60 Ah

*Power at 12.6V @ 60Hz following the ANSI / CTA-2006B standard with a maximum THD of 1%

DIMENSIONS

400.2D EVO / 400.4D EVO / 400.4S EVO

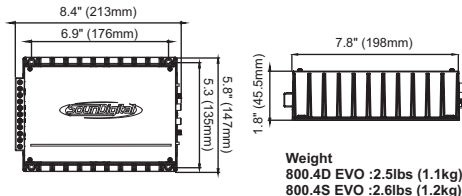

TECHNICAL SPECS

PARAMETER	400.4S EVO	800.4S EVO 2Ω	800.4S EVO 4Ω
Bridge RMS Power @ 8Ω*	2 x 110W	2 x 120W	2 x 220W
Bridge RMS Power @ 4Ω*	2 x 200W	2 x 220W	2 x 400W
Bridge RMS Power @ 2Ω*	N/A	2 x 400W	N/A
RMS Power per channel @ 4Ω*	4 x 55W	4 x 60W	4 x 110W
RMS Power per channel @ 2Ω*	4 x 100W	4 X 110W	4 X 200W
RMS Power per channel @ 1Ω*	N/A	4 x 200W	N/A
Frequency response (-3db)	5Hz to 20kHz	5Hz to 20kHz	5Hz to 20kHz
Crossover 12dB/oct HP	45Hz to 850Hz	45Hz to 850Hz	LP - 45Hz to 850Hz
Crossover 12dB/oct LP	45Hz to 850Hz	45Hz to 850Hz	HP - 45Hz to 850Hz
Operating voltage	9V to 16V	9V to 16V	9V to 16V
SNR	88dB	99dB	99dB
THD+N (50% Rated Power)	0.006%	0.022%	0.022%
THD+N (10% Rated Power)	0.009%	0.031%	0.031%
Input sensitivity	0.5 to 6V	0.5 to 6V	0.5 to 6V
Current draw (music)	20A	39A	39A
Max current draw (resistive load 1kHz @ 12,6V)	40A	78A	78A
Total efficiency(full power @12,6V)	79.00%	81.60%	81.60%
Damping factor	55	55	55
Gross weight	2,09lbs	2,97lbs	2,97lbs
Giftbox dimensions (LxAxP)	7" x 3.5" x 5.9"	10.2" x 3.5" x 6.9"	10.2" x 3.5"x 6.9"
Size of recommended cable (power)	8 AWG (8mm ²)	7 AWG (10mm ²)	7 AWG (10mm ²)
Size of recommended cable (output)	2 x 15 AWG (1,5mm ²)	2 x 15 AWG (1.5mm ²)	2 x 15 AWG (1.5mm ²)
Fuse/Circuit breaker (music)	20A	40A	40A
Recommended capacity of the battery	35 Ah	60 Ah	60 Ah

*Power at 12.6V @ 60Hz following the ANSI / CTA-2006B standard with a maximum THD of 1%

LIMITED WARRANTY

SounDigital warrants the original purchaser that this product shall be free of defects in materials and workmanship for a period of twelve (12) months from the original date of purchase. Some countries have extended warranty in case the product is installed by an authorized dealer. This warranty is not transferrable and applies only to the original customer from an authorized **SounDigital** dealer.

- Incorrect installation or non-conformity with the Manual;
- Maintenance made by unauthorized personnel;
- Alteration or removal of the seal/serial number;
- Exposure to adverse conditions (weather, humidity, etc.);
- Damage caused by fall, impact or natural depreciation, caused by transport and/or handling, risks or smashing's;
- Product was purchased more than 12 months ago.

Warranty Covers:

- Component or material with manufacturing defects;
- Workmanship/service needed to repair the equipment;

Observations:

- Any extra information you can get by contacting us at the e-mail address: info@soundigitalusa.com;
- In case of manufacturing defect or bad quality of raw material the max compensation will be the replacement of the product, not allowing any kind of compensation payment;
- New modifications/iterations on a product don't obligate the manufacturer to modify products formerly produced.



www.sounddigitalusa.com



+ 1 786-600-1056



[/SounDigitalUSA](https://www.facebook.com/SounDigitalUSA)



[@soundigitalUSA](https://www.instagram.com/soundigitalUSA)