



YOUR MUSIC. **YOUR POWER.**

**OWNER'S MANUAL**  
**800.4** **EVOX**

**EVOX**

Introduction .....	3
Package contents .....	3
Safety instructions .....	4
Technologies	
DTR.....	5
Ultra Compact PCB.....	5
Vibration Absorption Device.....	6
Low Battery consumption.....	6
Assembling and Disassembling the plastic cover.....	7
Panels description	
Audio inputs and controls.....	8
Power inputs and audio outputs (until 09/2020).....	9
Power inputs and audio outputs (from 10/2020).....	10
Electrical Dimensioning.....	11
Audio inputs	
RCA inputs.....	11
High inputs.....	11
Installation sequence.....	12
Wiring diagram	
Four channels wiring diagram.....	13
Three channels wiring diagram.....	13
Two channels wiring diagram.....	14
Procedure for setting the gain.....	14
Crossovers set up.....	15
Technical specs	
Parameters.....	16
Dimensional data.....	16

**DEAR CUSTOMER,**

**CONGRATULATIONS ON ACQUIRING A PRODUCT WITH THE HIGHEST QUALITY AND TECHNOLOGY!**

You have just purchased a **SoundDigital** product of the highest technology and quality, so we thank you for your confidence.

**SoundDigital** products are made with raw materials of the highest quality standards, and the most modern processes, equipment and technology are used in their production.

On this manual you will learn about the product, its features and characteristics, in order to obtain the best result and to be able to enjoy your music with **SoundDigital** quality and power.

To better understand and take advantage of all the functions of the product and use it safely, read this manual carefully and if you have any questions, consult our support by email [info@sounddigitalusa.com](mailto:info@sounddigitalusa.com).

**PACKAGE CONTENTS**

- 1 EVOX Amplifier
- 1 Installation quick guide with warranty card
- 1 Allen wrench 2.5mm
- 2 Cables for high level input
- 1 Promotional sticker

To prevent injuries to the user or damage to the amplifier, read all safety instructions written on this manual;

If you are insecure about the installation of this equipment, get in touch with our tech support or with a professional specialized in car audio installation;

Before proceeding with the installation of any electric equipment on your vehicle, unplug the negative (-) terminal of the battery to avoid fires, injuries or damages;

Use your sound system safely. The continuous exposure to sound pressures over 85dB may cause irreversible hearing damage;

This equipment is for use in automotive DC voltage batteries between 12.6 and 14.4 volts. Before installing the equipment, check voltage of the batteries;

Do not install the amplifier in places exposed to water, dirt or humidity;

Choose a ventilated place to install the amplifier and avoid blocking the side ventilation windows;

Mount the amplifier in a secure way. Avoid mounting it on metallic parts of the vehicle, because it may cause ground looping (noise);

Make sure that the location chosen for the amplifier installation does not effect the operation of the vehicle;

When passing cables through metallic walls, use rubber O-rings to avoid cable cutting and short-circuits.

Clean the amplifier periodically with brush or dry cloth to assure the thermal efficiency of the heatsink.

This product may reach temperatures over 60°C/140°F. Make sure it is cold before touching it;

Be careful when making holes in the vehicle. Make sure you are not making holes in the fuel tank, brake lines or electrical cables of the vehicle

Make sure the cables are properly secured throughout the installation;

Wear gloves, safety glasses and and all necessary PPE during the installation of SounDigital amplifiers.



**Warning!**

THIS "WARNING" SIGN ALERTS THE USER OF IMPORTANT INFO. NOT FOLLOWING THIS INSTRUCTIONS MAY CAUSE INJURIES TO THE USER OR DAMAGE TO THE EQUIPMENT.

## DYNAMIC THERMAL RECOVERY - DTR

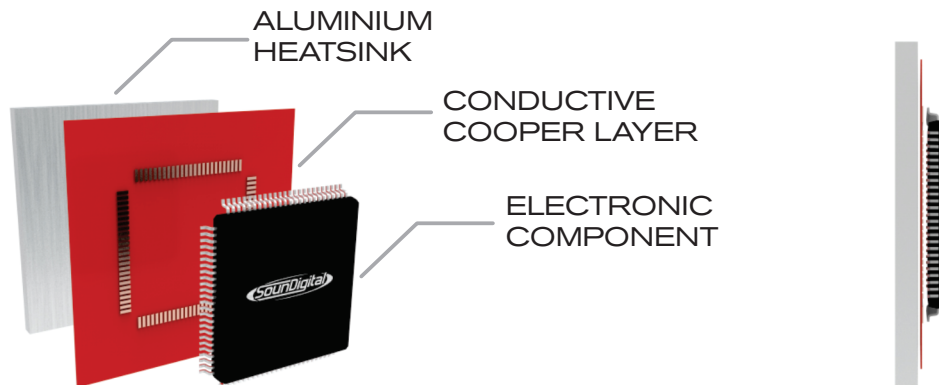

The **DTR**\* is a dynamic thermal recovery system which always maintains a high efficiency of the amplifier by accelerating the thermal exchange of electronic components with the heatsink

*\* Patent. Required*

## ULTRA COMPACT PCB

An intelligent layout, with great use of the PCB area and the use of modern components with reduced structure guarantee **SounDigital** products a compact design, at the same time robust and with excellent thermal efficiency.

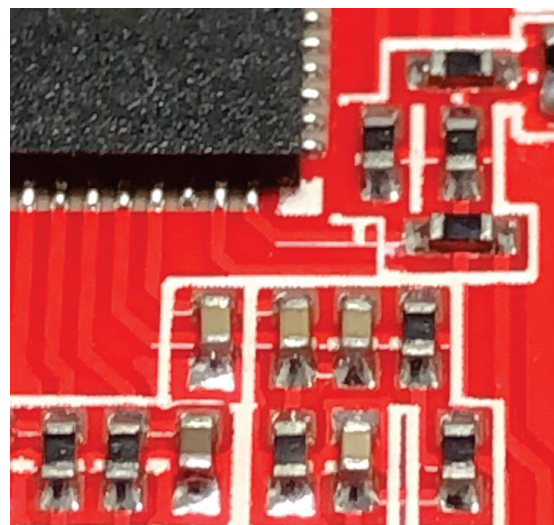

## VIBRATION ABSORPTION DEVICE

SounDigital added a new device to the EVO X products which act like shock absorbers reducing the impact of vibration on the electronic circuit board, thereby increasing the life and reliability of the amplifiers.

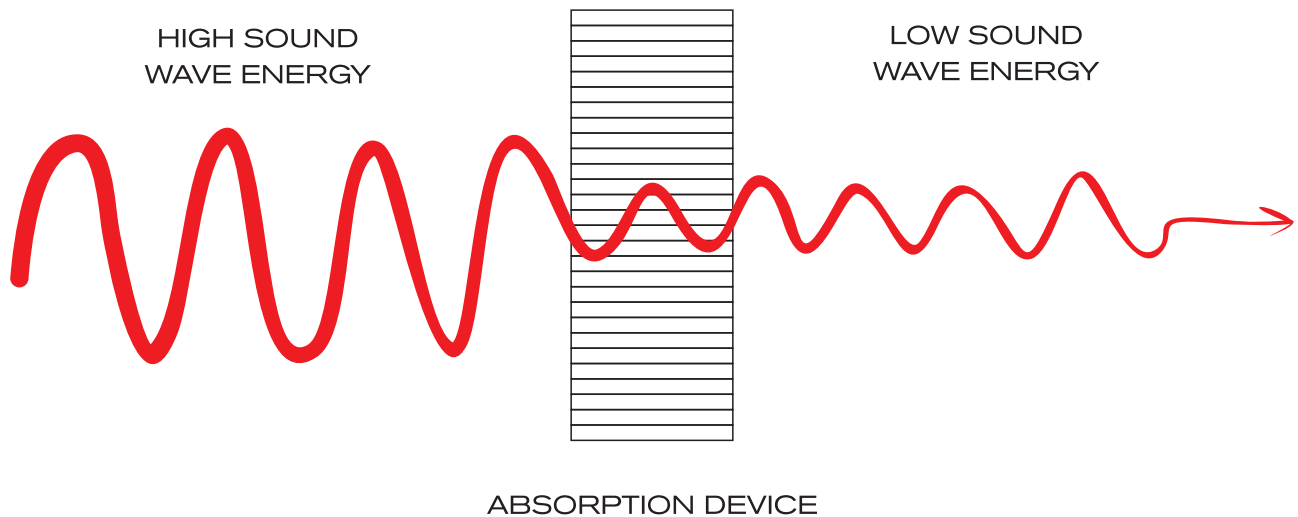

## I - POWER SUPPLY

SounDigital amplifiers are known for their low consumption of battery, and this feature was improved on the **EVOX Line**. The new **I-POWER SUPPLY** is even more modern, which replaces the old toroidal transformers by a new generation of "E-E" core transformers delivers efficiency above 90% \*, ensuring more hours of sound without battery recharge.

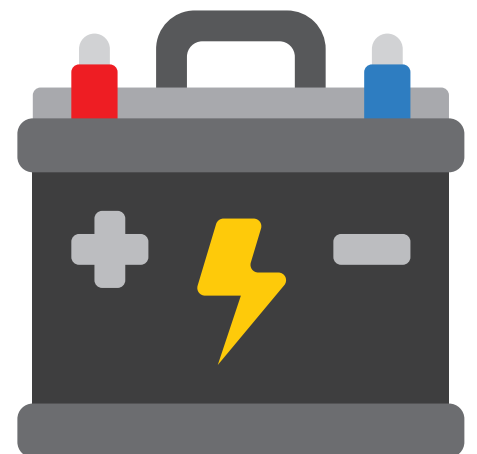

\*Efficiency measured at power supply only

The plastic covers have the function of finishing and hiding the amplifier fixing screws. To disassembling and assembling them, follow the instructions below.

### DISASSEMBLING OF THE PLASTIC COVER

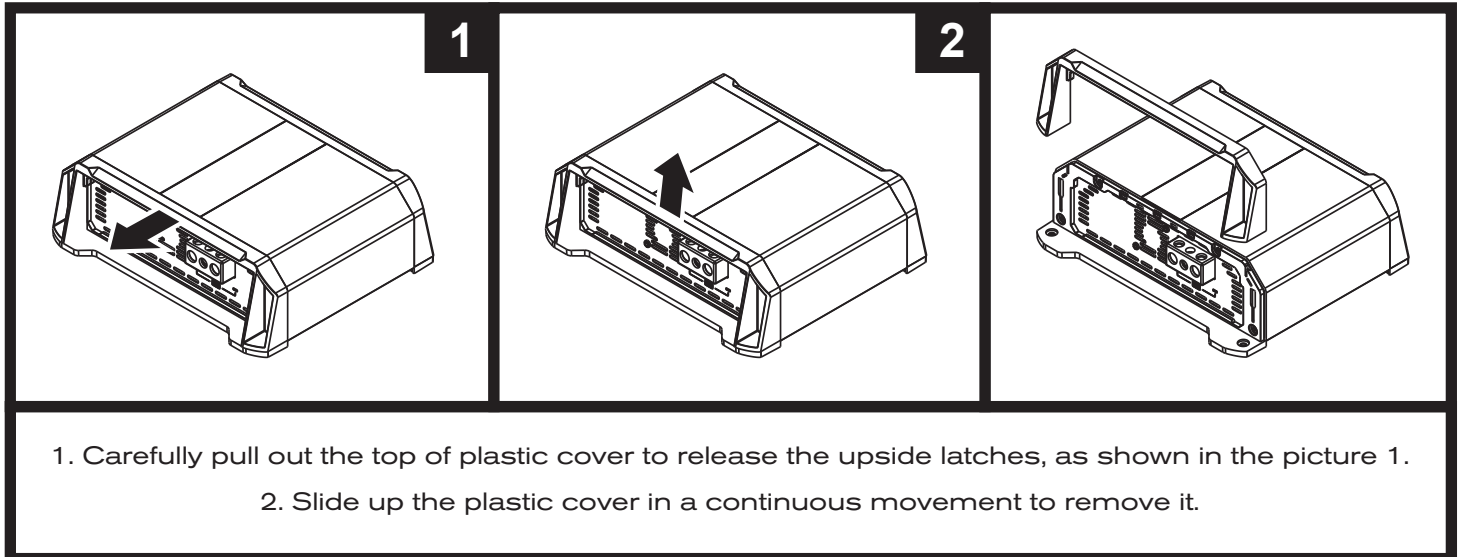

### ASSEMBLING THE PLASTIC COVER

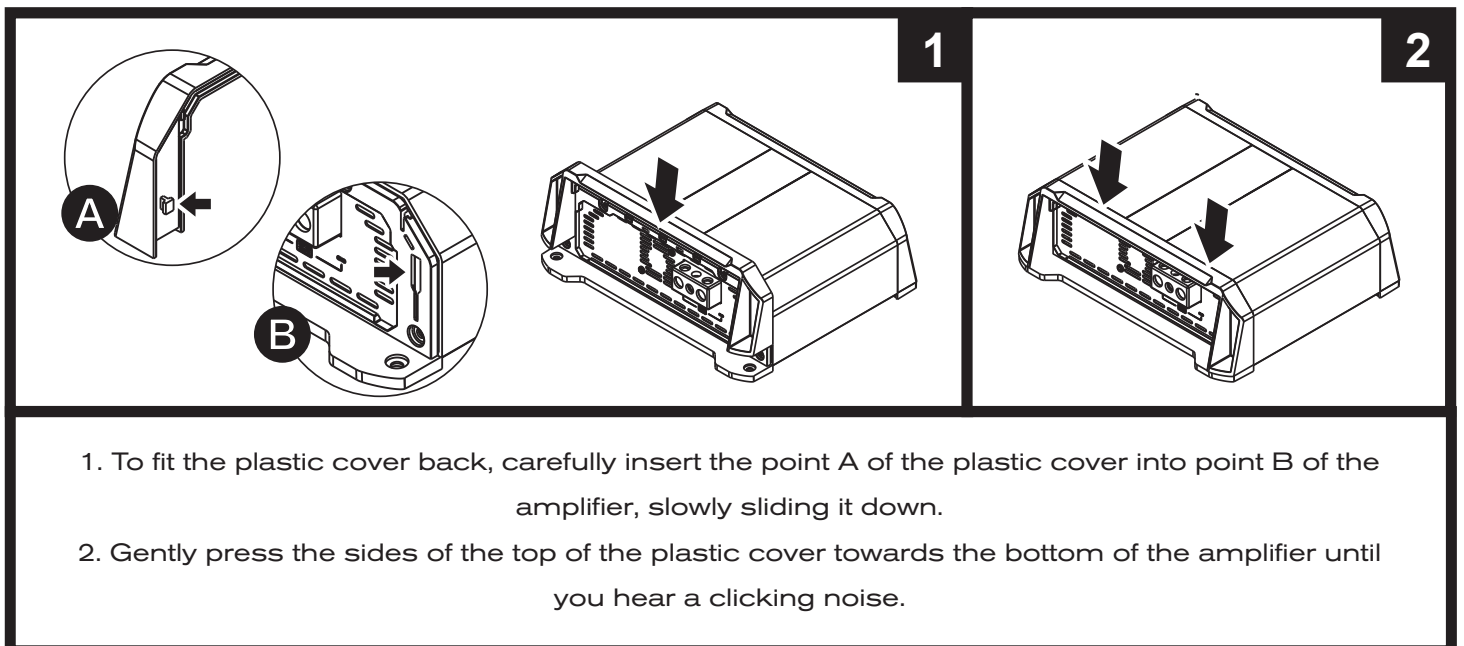

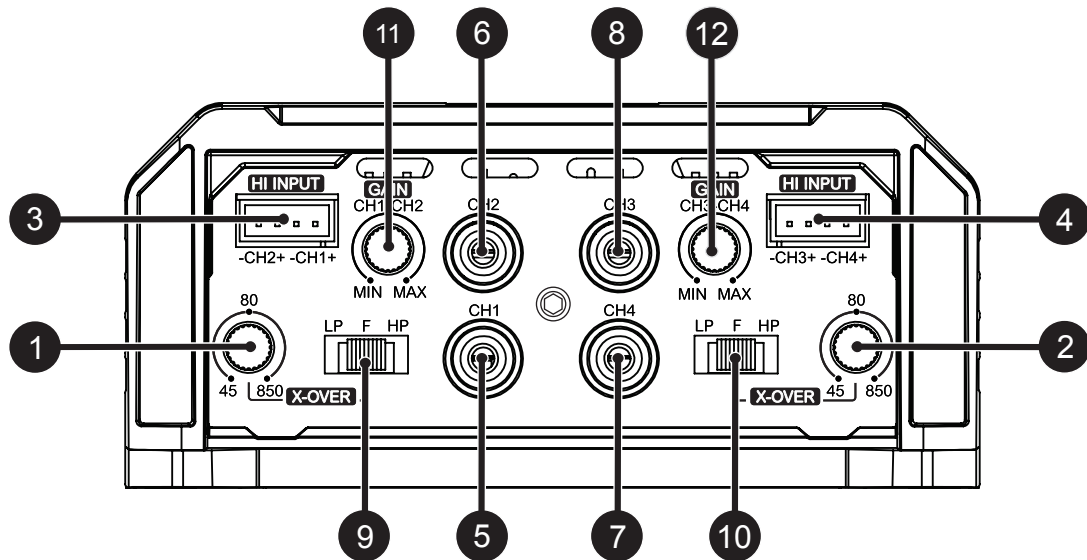

1	CH1/CH2	Variable crossover control - 45Hz to 850Hz
2	CH3/CH4	Variable crossover control - 45Hz to 850Hz
3	CH1/CH2	High Level audio input (To connect to the speaker output of the headunit)
4	CH3/CH4	High Level audio input (To connect to the speaker output of the headunit)
5	CH1	Audio input - RCA connector
6	CH2	Audio input - RCA connector
7	CH4	Audio input - RCA connector
8	CH3	Audio input - RCA connector
9	CH1/CH2	Crossover Switch Low Pass - Full - High Pass
10	CH3/CH4	Crossover Switch Low Pass - Full - High Pass
11	CH1/CH2	Variable Gain Control
12	CH3/CH4	Variable Gain Control



Products manufactured until September 2020

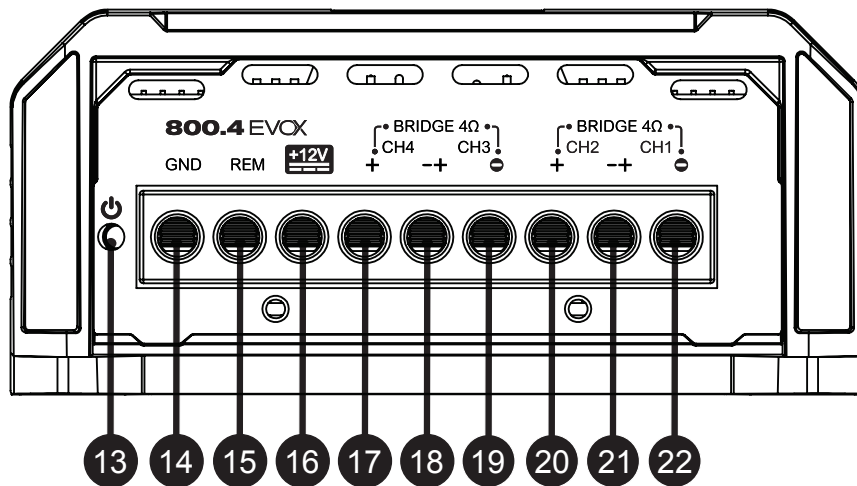

13	-	"Power ON" LED indicator (Blue)
14	-	Negative power supply connector (GND)
15	-	Remote power supply connector (REM)
16	-	Positive power supply connector (+12VDC)
17	CH4	Positive speaker connector
18	CH3/CH4	Shared connector between channels 3 (+) and 4 (-)
19	CH3	Negative speaker connector
20	CH2	Positive speaker connector
21	CH1/CH2	Shared connector between channels 1 (+) and 2 (-)
22	CH1	Negative speaker connector

Products manufactured from October 2020

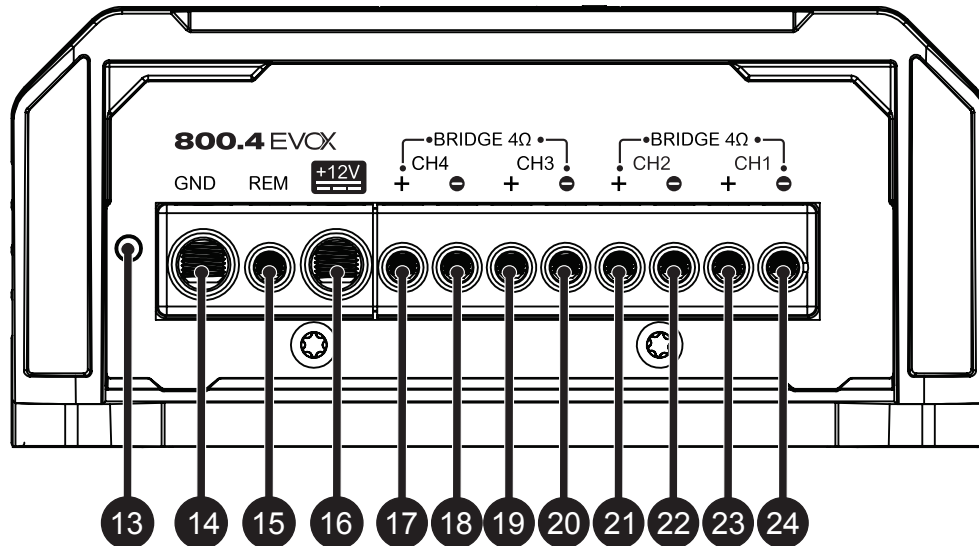

13	-	"Power on" LED indicator (Blue)
14	-	Negative power supply connector (GND)
15	-	Remote power supply connector (REM)
16	-	Positive power supply connector (+12v)
17	CH4	Positive audio output connector
18	CH4	Negative audio output connector
19	CH3	Positive audio output connector
20	CH3	Negative audio output connector
21	CH2	Positive audio output connector
22	CH2	Negative audio output connector
23	CH1	Positive audio output connector
24	CH1	Negative audio output connector

## ELECTRICAL DIMENSIONING

For proper operation of your SounDigital amplifier, you need the proper dimensioning of the electrical system and the cables used.

The table below shows the minimum section of GND cables, +12VDC cables and speaker output cables according to the power generated by the amplifier.

800 WRMS	POWER CABLE	10mm <sup>2</sup> - 7 AWG
	GROUND CABLE	
	SPEAKER CABLE	2 x 1.5mm <sup>2</sup> - 15 AWG

We recommend the use of ONLY OFC (Oxygen Free Copper) Cables on the installation of our products.

## AUDIO INPUTS

### RCA Inputs

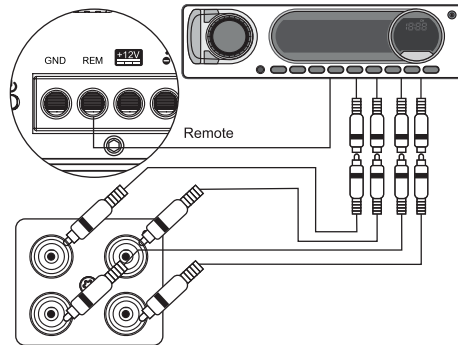

All RCA Inputs must be connected for the 4 channels to work.

### High signal inputs

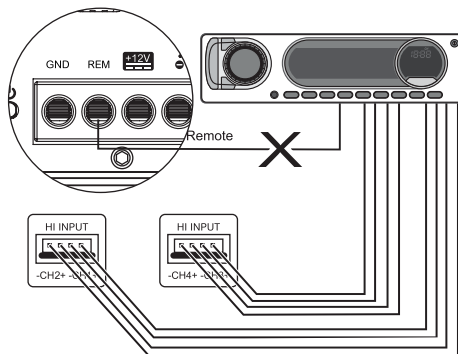

All High signal Inputs must be connected for the 4 channels to work.

High input must be used when the main unit does not have RCA outputs.

When hi inputs is used, no remote connection is required, the amplifier recognizes the audio signal and switches on.

If your source unit is not able to turn on the amplifier through the high level input, the remote input should be connected normally.



**RCA AND HIGH INPUTS SHOULD NOT BE USED SIMULTANEOUSLY OR YOU MAY DAMAGE THE AMPLIFIER.**

**Warning!**

**Warning!**

BEFORE PROCEEDING WITH THE INSTALLATION, UNPLUG THE NEGATIVE TERMINAL FROM ALL OF THE BATTERIES, TO AVOID FIRE, DAMAGE TO THE AMPLIFIER AND THE USER HIMSELF.

- Mount the amplifier in such a way you have access to the connectors;
- Install the power cables in the vehicle properly, starting from the battery to the fuse holder or circuit breaker, use the cable with the appropriate size. Make all connections, install fuse holders or circuit breakers, but without placing the fuses or with the circuit breakers in the "Off" position.

**Warning!**

THE MAX. DISTANCE FOR THE INSTALLATION OF THE FUSE/CIRCUIT BREAKER IS ONE FOOT (30 CM) AWAY FROM THE BATTERY.

- Connect the power cables in to the amplifier, observing the polarity. Connect all the positive cables from the fuse holder or circuit breaker to the positive connector of the amplifier and all the negative power cables from the batteries to the negative connector of the amplifier;
- The ground cable must be as short as possible and must be connected to the vehicle chassis and the battery negative;

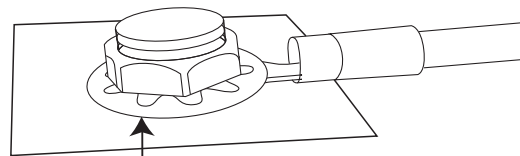

Remove the paint between the terminal and chassis

- Install the signal input cables in a proper way, distant from the power cables;
- Connect the RCA or the high signal input cables to the head unit and amplifiers;
- Install the audio output cables with the appropriate section, distant from the power and audio input cables;
- Connect the audio output cables to the amplifier and speakers respecting the positive (+) and negative (-) polarities;
- Install the remote cable with the power cables, using 1.5mm<sup>2</sup> (15 AWG) cable or thicker;
- Connect the remote power cable to the amplifier's "REM" terminal at the main unit's remote power output (when not using the high level signal inputs);
- Before powering the system, verify all the connections and make sure there are no mistakes or short-circuits on the power and ground cables;
- Reconnect the ground of the batteries;
- Check if the headunit is turned off and then place the fuses in the fuse holders or switch the circuit breakers on;
- Turn on the main unit and the amplifier will turn on the "On" LED indicating that it is in operation.

## 4 CHANNEL WIRING DIAGRAM

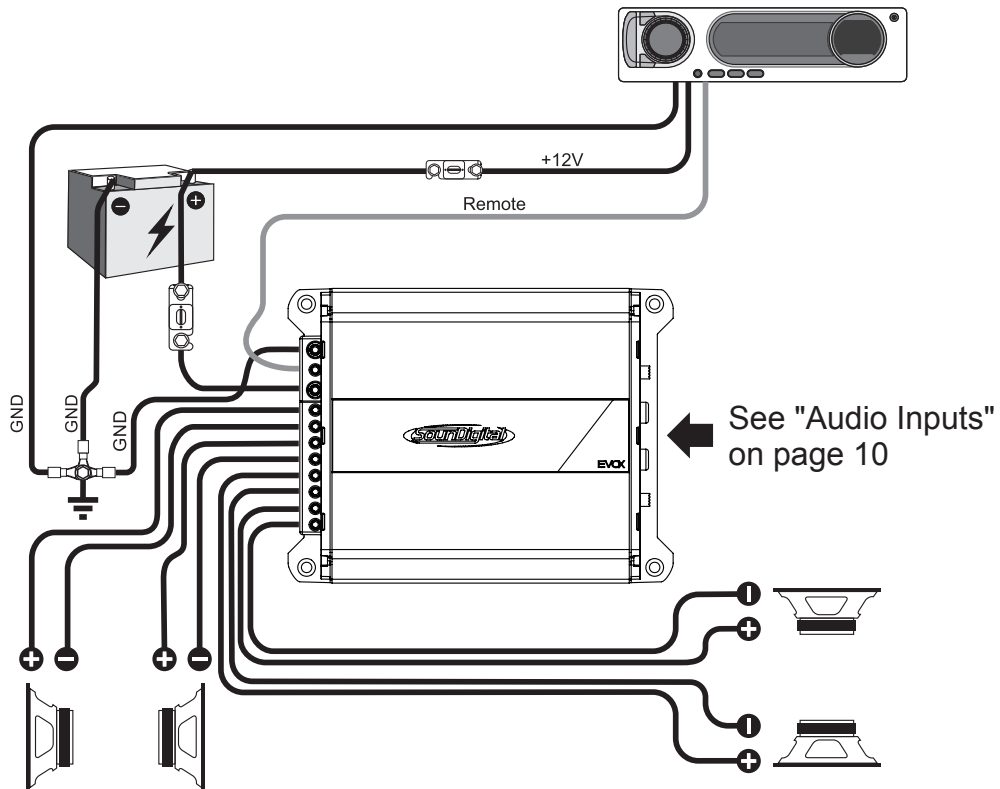

\* Check the minimum speaker impedance at spacs table

## 3 CHANNEL WIRING DIAGRAM

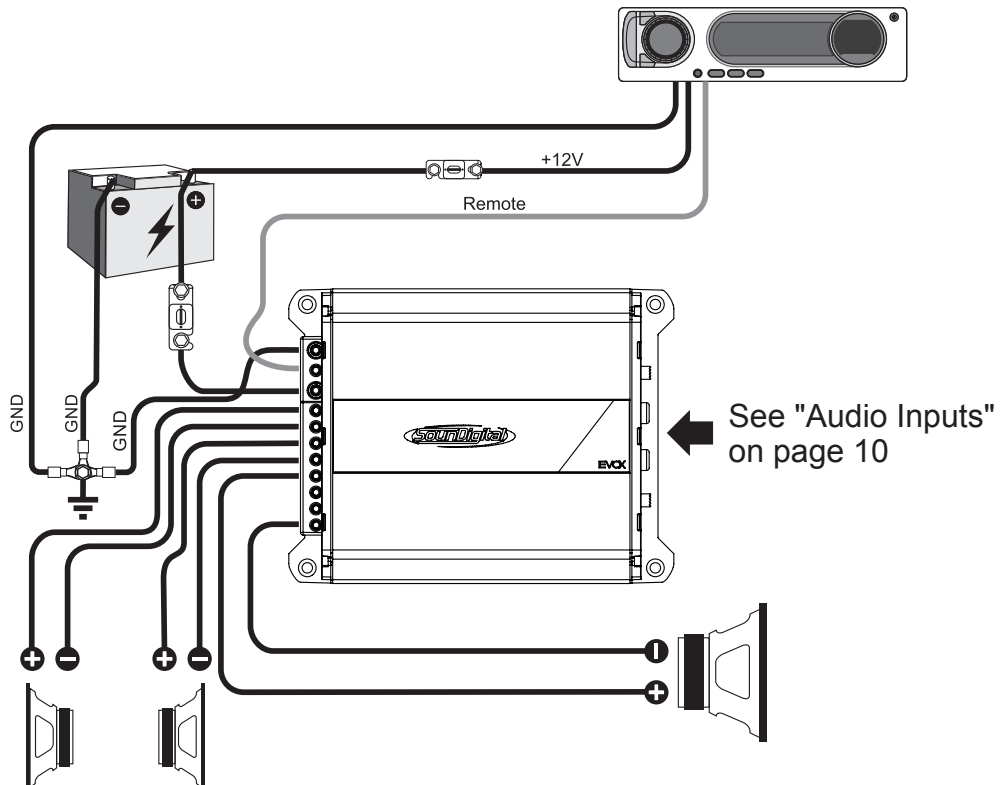

\* Check the minimum speaker impedance at spacs table

## 2 CHANNEL WIRING DIAGRAM

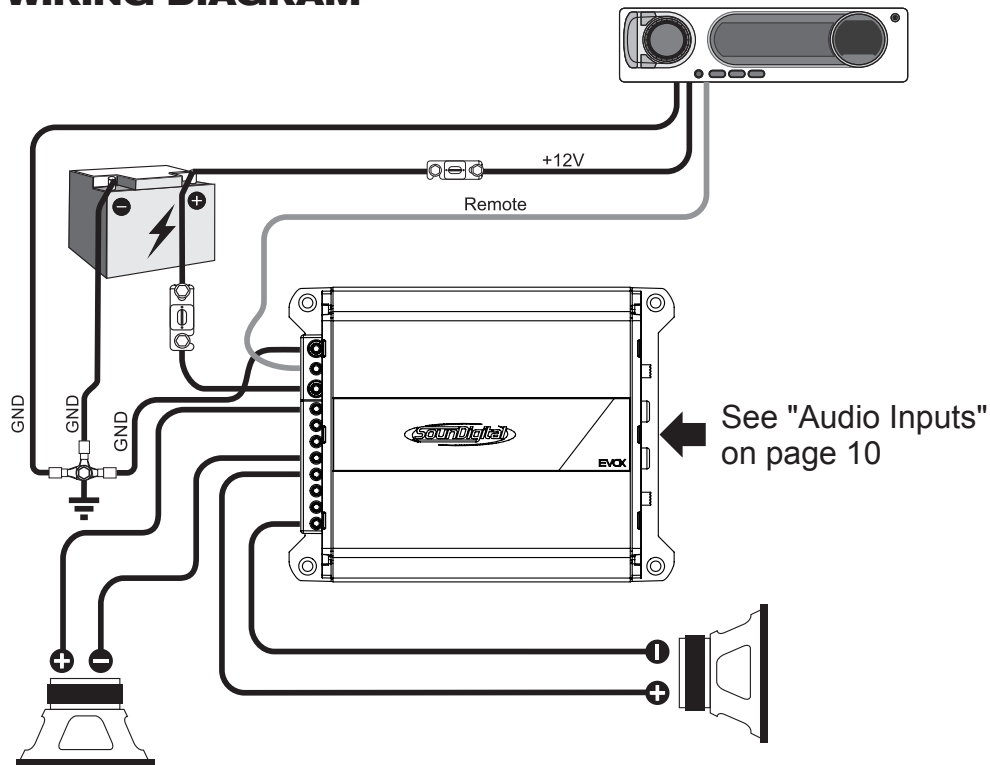

\* Check the minimum speaker impedance at specs table

### GAIN SETTING

Necessary equipment:

- Digital AC voltmeter;
- Media with sine wave test tone 60Hz recorded at 0db;
- Screwdriver 1/8" (for gain set)

### Set up procedure

- This procedure is the same for both gain controls;
- Turn the gain control all the way down.
- Disconnect the output cables from the amplifier outputs;
- Turn off all processing (bass, treble, loudness, EQ, etc.);
- Set the source unit volume to 3/4 of full volume.

- Set the source unit's fader control to center position;
- Set the crossover selector switch in "F"
- Use a 60 Hz sine wave
- Connect the AC voltmeter to the speaker output connectors of the amplifier. Make sure you test the voltage at the correct connectors (+ and -);
- Increase the gain control until the target voltage is observed with the voltmeter (see the chart below);
- Once you have adjusted the amplifier to its correct voltage output, turn off the source unit and reconnect the speaker(s)

Download the tracks for set up in <https://sounddigitalusa.com/tracks-for-set-up/>

MODEL	STEREO / POWER	BRIDGE / POWER	STEREO OUTPUT VOLTAGE	BRIDGE OUTPUT VOLTAGE
<b>800.4</b> EVOX	2Ω/ 200W	4Ω/ 400W	20.0 V	40.0 V

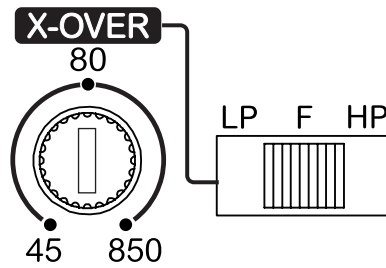

"F" All the frequencies are reproduced;  
 "LP " Set in the variable control on Low Pass Function;  
 "HP " Set in the variable control on High Pass Function.

- Switch Key to "F" position (Full Range): All the frequencies are reproduced.

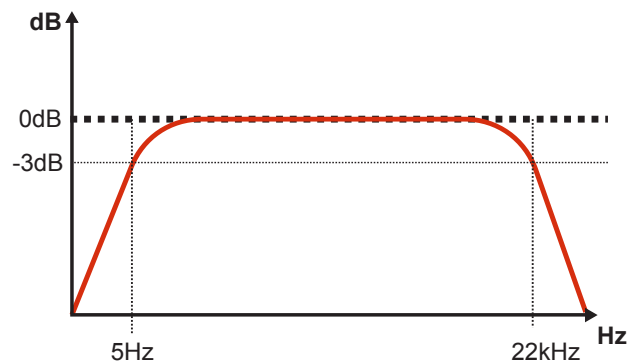

- Switch key to "HP" - Set in the variable control between 45Hz and 850Hz ("A") where you want to perform the high pass cut filter;

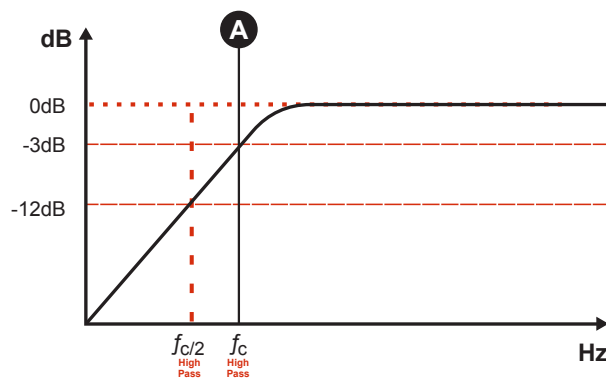

- Switch key to "LP" - Set in the variable control between 45Hz and 850Hz ("B") where you want to perform the low pass cut filter;

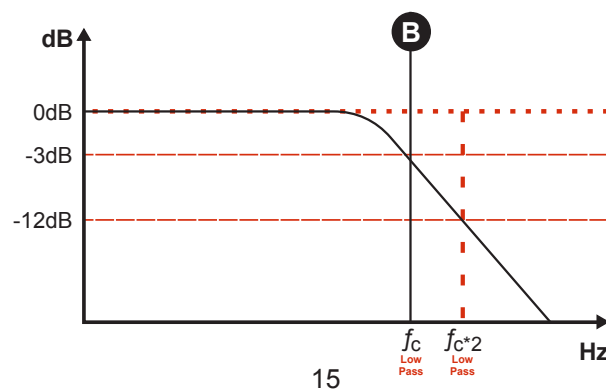

PARAMETERS	800.4 EVOX
Power RMS Bridge @ 8Ω*	2 X 264W
Power RMS Bridge @ 4Ω*	2 X 400W
Power RMS @ 4Ω*	4 X 132W
Power @ 2Ω*	4 X 200W
Frequency Response (-3dB)	5Hz ~ 22kHz
Low Pass filter (12dB/oct)	45Hz ~ 850Hz
High Pass filter (12dB/oct)	45Hz ~ 850Hz
Operating Voltage	8V ~ 16V
SNR	91dB
Input Sensitivity	0.2 ~ 4V
Current Draw (Music)	40A
Current Draw (Max)	80A
Total Efficiency	79%
Damping Factor (@100Hz nominal impedance)	200
Stereo Minimum Impedance	2Ω
Bridge Minimum Impedance	4Ω
Fuse (music)	40A
Recommended battery	60Ah

\*Power at 12.6V @ 60Hz with a maximum THD of 1%.

## DIMENSIONAL DATA

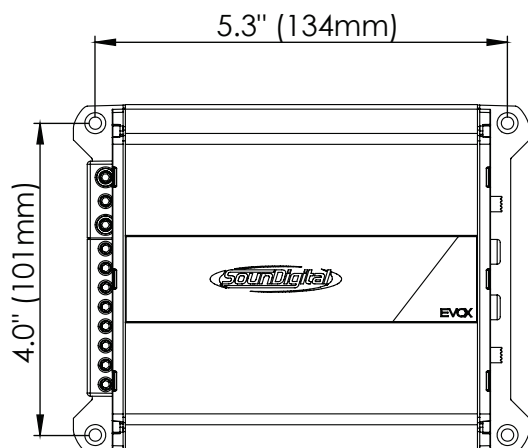
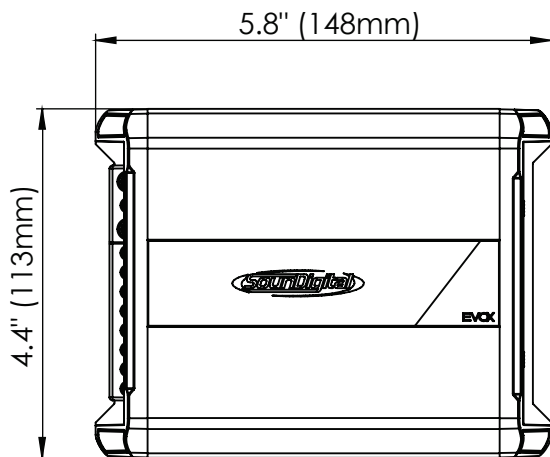

Net Weight: 1.45 lb (0.66 kg)  
Gross Weight: 1.74 lb (0.80 kg)

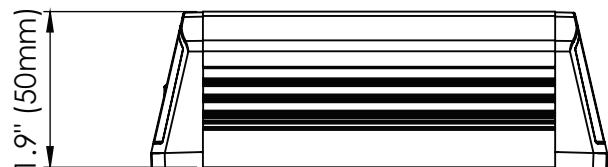





YOUR MUSIC. **YOUR POWER.**



Consumer  
Technology  
Association™



[WWW.SOUNDIGITALUSA.COM](http://WWW.SOUNDIGITALUSA.COM)



[SOUNDIGITALUSA](https://www.facebook.com/SOUNDIGITALUSA)



[SOUNDIGITALUSA](https://www.instagram.com/SOUNDIGITALUSA)