



YOUR MUSIC. **YOUR POWER.**

EVO<sup>4.0</sup>

**OWNER'S MANUAL**  
**8000.1 EVO<sup>4.0</sup>**

Introduction.....	3
Package contents .....	3
Safety instructions.....	4
Assembling and disassembling the plastic cover .....	5
Panels description	
Controls, audio inputs and outputs .....	6
Amplifier power supply.....	7
Installation sequence.....	8
Electrical dimensioning.....	9
Audio connectors	
RCA input and output.....	9
SD RLC and Gain Setting.....	10
Bass Boost set up .....	11
Crossovers set up.....	11
Wiring diagram .....	12
Battery connection diagram .....	13
Technical specifications	
Parameters .....	14
Dimensional data.....	14
Additional Information .....	14

## Dear Consumer,

Congratulations, you have just acquired a SoundDigital product of the highest technology and quality, so we thank you for your trust.

SoundDigital products are made with raw materials of the highest quality standards, and the most modern processes, equipment and technology are used in their production.

## IMPORTANT INFORMATION

On this manual you will learn about the product, its features and characteristics, in order to obtain the best result and to be able to enjoy your music with SoundDigital quality and power.

Read this manual carefully and follow precisely all the information contained therein, these are very important and allow your amplifier to work optimally. If you think it is necessary, please do not hesitate to contact our technical support at the following contact:







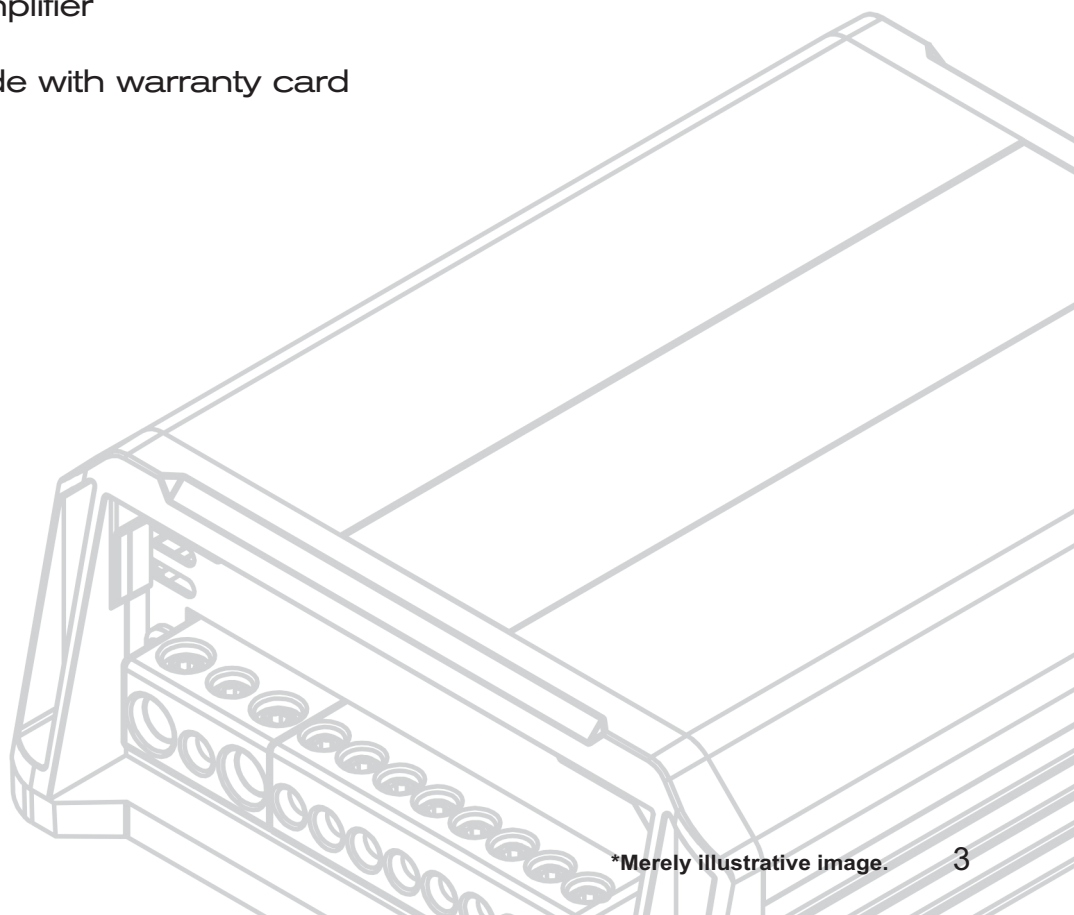

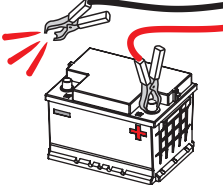
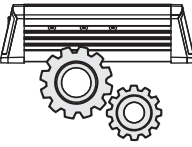

✉ [info@soundigitalusa.com](mailto:info@soundigitalusa.com)

## PACKAGE CONTENTS

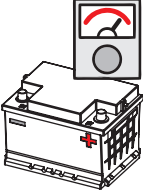
- 01 **8000.1 EVO4.0** Amplifier
- 01 Installation quick guide with warranty card
- 01 Promotional sticker

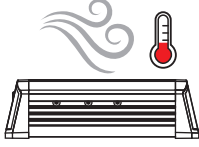
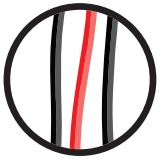
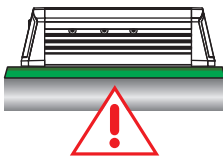

To avoid injury to the user or damage to the amplifier, read all safety instructions written on this manual.

<p>The installation of this product must be done by a qualified professional. In case of any doubt, please contact our technical support;</p>		 <p>When passing cables through metallic walls, use rubber O-rings to avoid cable cutting and short-circuits;</p>
<p>Before proceeding with the installation of any electric equipment on your vehicle, unplug the negative (-) terminal of the battery to avoid fires, injuries or damages;</p>		 <p>Make sure that the chosen location for the amplifier installation does not affect the operation of the vehicle;</p>
<p>Use your sound system safely. The continuous exposure to sound pressures over 85dB may cause irreversible hearing damage;</p>		 <p>This product may reach temperatures over 60°C (140°F). Make sure it is cold before touching it;</p>
<p>This equipment is for use in automotive DC voltage batteries between 12.6 and 14.4 volts. Before installing the equipment, check voltage of the batteries;</p>		 <p>Clean the amplifier periodically with brush or dry cloth to assure the thermal efficiency of the heatsink;</p>
<p>Do not install the amplifier in places exposed to water, dirt or humidity;</p>		 <p>Be careful when making holes in the vehicle. Make sure you are not making holes in the fuel tank, brake lines or electrical cables of the vehicle;</p>
<p>Choose a ventilated place to install the amplifier and avoid blocking the side ventilation windows;</p>		 <p>Make sure the cables are properly secured throughout the installation;</p>
<p>Fix the amplifier properly and firmly. Avoid fixing to metallic parts of the vehicle, as this procedure may cause ground looping (noise);</p>		 <p>Wear gloves, safety glasses and all necessary PPE during the installation of Soundigital amplifiers.</p>



**Warning!**

THIS "WARNING" SIGN ALERTS THE USER OF IMPORTANT INFO. NOT FOLLOWING THESE INSTRUCTIONS MAY CAUSE INJURIES TO THE USER OR DAMAGE TO THE EQUIPMENT.

The plastic covers have the function of finishing and hiding the amplifier fixing screws. To disassembling and assembling them, follow the instructions below.

### DISASSEMBLING OF THE PLASTIC COVER

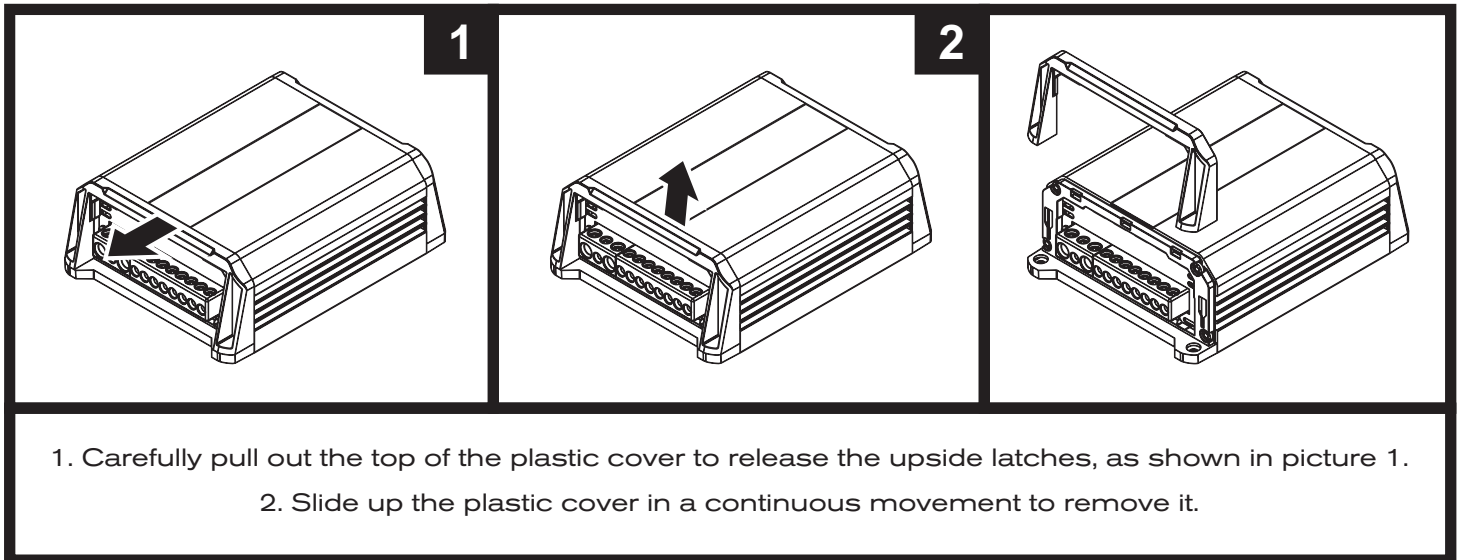

\*Merely illustrative images.

### ASSEMBLING THE PLASTIC COVER

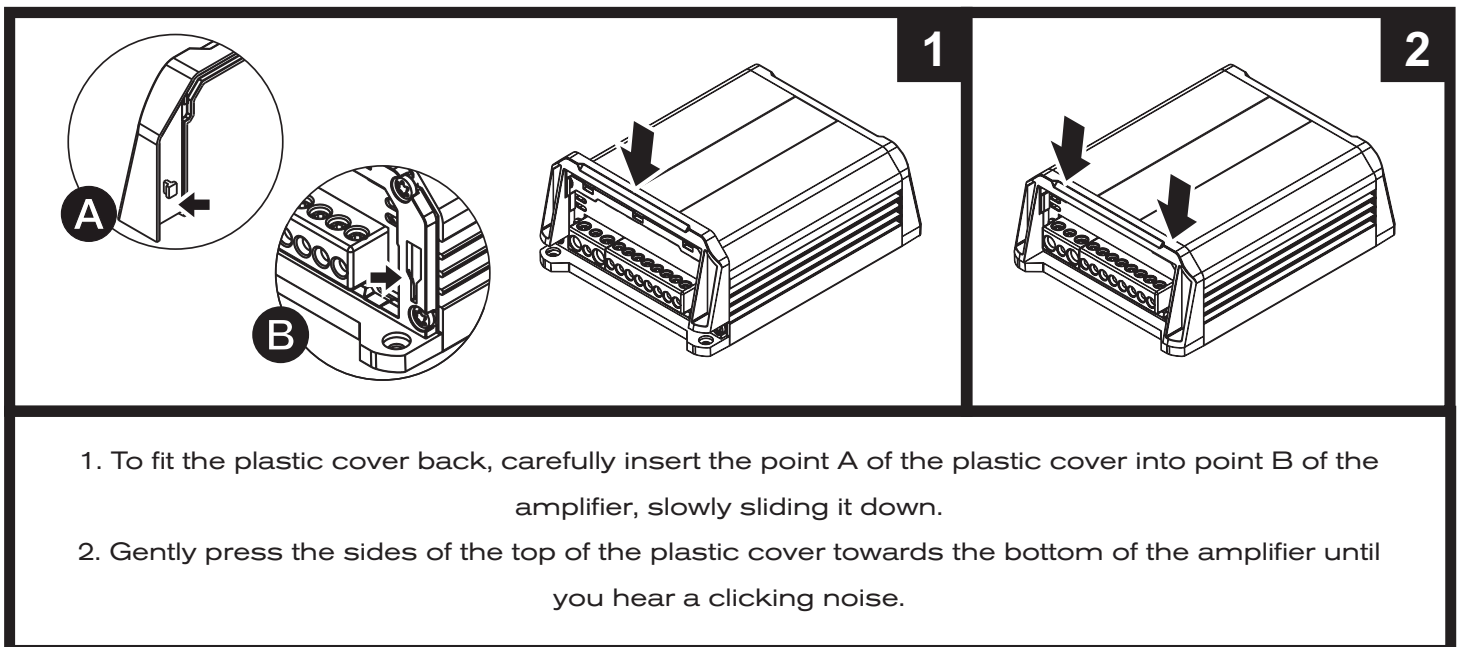

\*Merely illustrative images.

## Controls, audio inputs and outputs

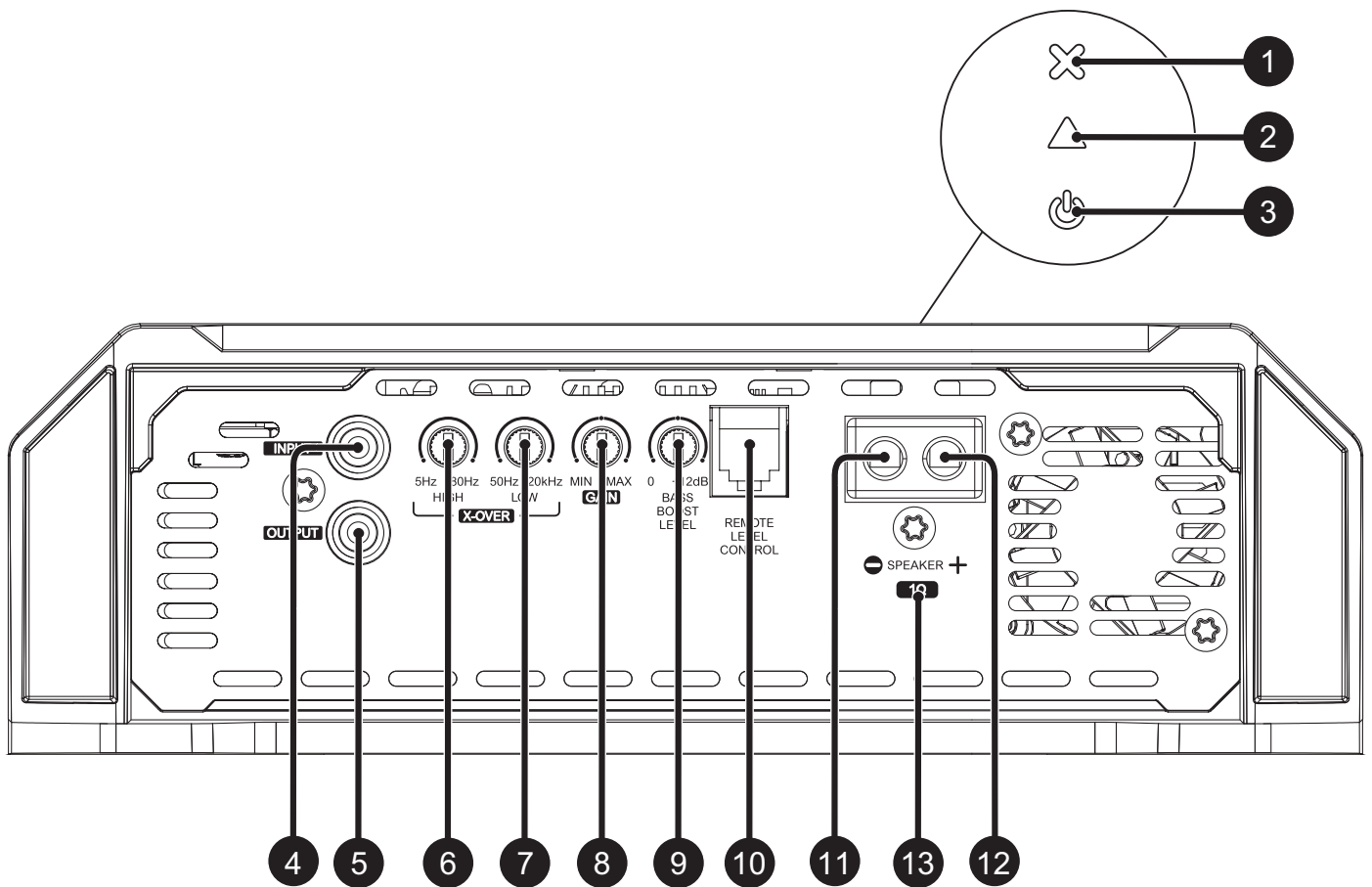

1	Red	"PROTECTION" LED indicator
2	Yellow	"CLIP" LED indicator
3	Blue	"POWER ON" LED indicator
4	Audio input	RCA connectors
5	Audio output	
6	-	Variable High Pass filter control (5Hz ~ 80Hz)
7	-	Variable Low Pass filter control (50Hz ~ 20kHz)
8	-	Variable Gain control
9	-	Variable Bass Boost Control 50Hz (0dB ~ +12dB)
10	-	Remote level control connector
11	Negative	Speaker output connector
12	Positive	
13	-	Minimum speaker load allowed (impedance)

## Amplifier power supply

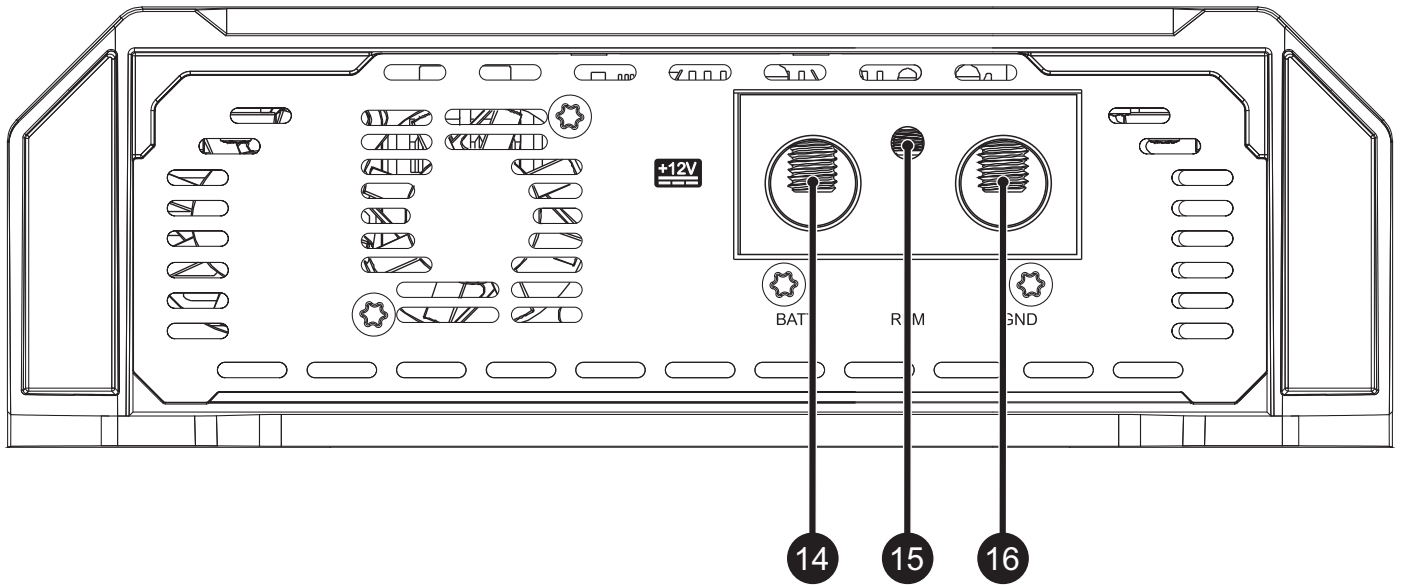

14	-	Positive power supply connector (+12VDC)
15	-	Remote power supply connector (REM)
16	-	Negative power supply connector (GND)

**Warning!**

BEFORE PROCEEDING WITH THE INSTALLATION, UNPLUG THE NEGATIVE TERMINAL FROM ALL OF THE BATTERIES, TO AVOID FIRE, DAMAGE TO THE AMPLIFIER AND THE USER HIMSELF.

- Mount the amplifier in such a way you have access to the connectors;
- Install the power cables in the vehicle properly, starting from the battery to the fuse holder or circuit breaker, use the cable with the appropriate size. Make all connections, install fuse holders or circuit breakers, but without placing the fuses or with the circuit breakers in the "OFF" position;

**Warning!**

THE MAXIMUM DISTANCE FOR THE INSTALLATION OF THE FUSE/CIRCUIT BREAKER IS 12 INCHES (30cm) AWAY FROM THE BATTERY.

- Connect the power cables in to the amplifier, observing the polarity. Connect all the positive cables (+) from the fuse holder or circuit breaker to the positive conector of the amplifier and all the negative power cables from the batteries to the negative connector of the amplifier;
- The ground cable must be as short as possible and must be connected to the vehicle chassis and the battery negative;

Remove the paint  
between the terminal  
and chassis

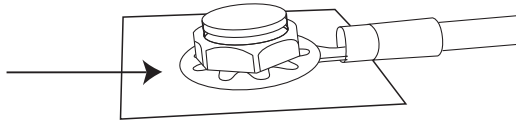

- Install the signal input cables in a proper way, distant from the power cables;
- Connect the RCA or the high level signal input cables to the head unit and amplifiers;
- Install the audio output cables with the appropriate section, distant from the power and audio input cables;
- Connect the audio output cables to the amplifier and speakers respecting the positive (+) and negative (-) polarities;
- Install the remote cable with the power cables, using 1.5mm<sup>2</sup> (15 AWG) cable or thicker;
- Connect the remote power cable to the amplifier's "REM" terminal at the main unit's remote power output (when not using the high level signal inputs);
- Before powering the system, verify all the connections and make sure there are no mistakes or short-circuits on the power and ground cables;
- Reconnect the ground of the batteries;
- Check if the head unit is turned off and then place the fuses in the fuse holders or switch the circuit breakers on;
- Turn on the main unit and the amplifier will turn on the "POWER ON" LED indicating that it is in operation.

**Warning!**

Minimum recommended  
installation distance  
between amplifiers\*.  
1.18in (30mm)

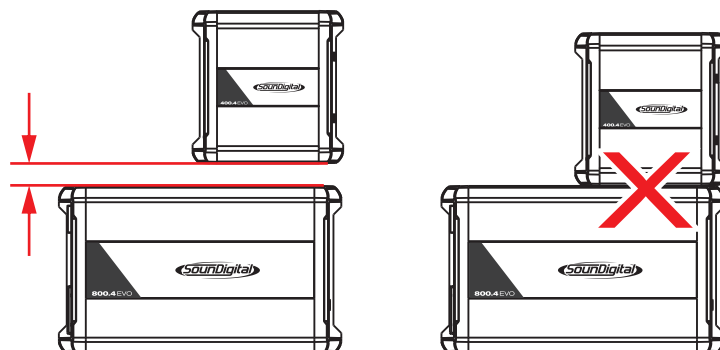

\*For installations with more than one amplifier, second unit not included. Merely illustrative images.



## ELECTRICAL DIMENSIONING

For proper operation of your SounDigital amplifier, you need the proper dimensioning of the electrical system and the cables used.

The table below shows the minimum section of GND cables, +12VDC cables and speaker output cables according to the power generated by the amplifier.

8000 WRMS	POWER CABLE (+12VDC)	70mm <sup>2</sup> (00 AWG)
	GROUND CABLE (GND)	
	SPEAKER CABLE	10mm <sup>2</sup> (7 AWG)

We recommend the use of only OFC (Oxygen Free Copper) cables on the installation of our products.

Copper-clad aluminum wire (CCAW) must not be used.

## AUDIO CONNECTORS

### RCA input and output

Example of one RCA cable connection only.

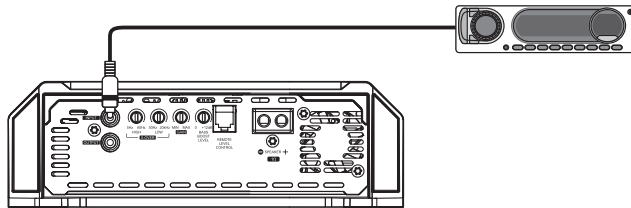

Example of two RCA cables connection (mono input).

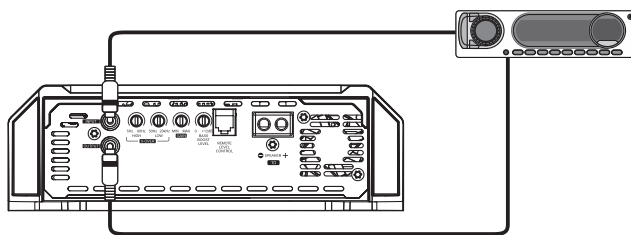

Example of one RCA cable connection only and using the RCA output to connect another amplifier.

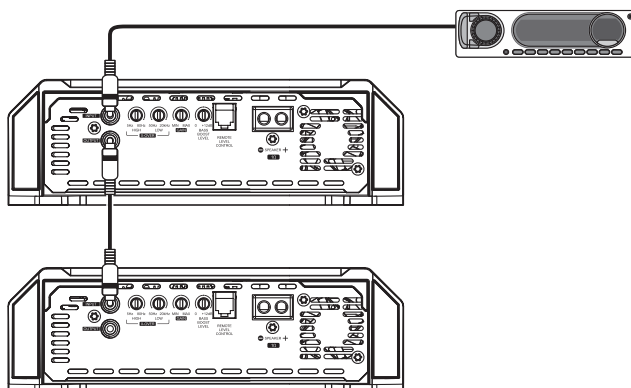

## EXTERNAL LEVEL CONTROL - SD RLC (\*Not included)

The SD RLC is an easy-to-install external level control accessory that allows you to tune the level of SOUNDIGITAL amplifiers that have remote level control.

In SD RLC, you can adjust the amplifier level without having to lean over and adjust the gain setting on the amplifier and can monitor the "CLIP" LED which is also available on the accessory.

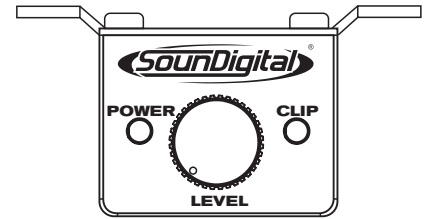

SD REMOTE  
LEVEL CONTROL\*

\*Sold separately

## GAIN SETTING

### Necessary equipment:

- Digital AC voltmeter;
- Media with sine wave test tone 60Hz recorded at 0db;
- Screwdriver 1/8" (for gain setting).
- Set the audio player fader control to center position (left and right fader controls);
- Set the variable "LOW" crossover in 20kHz and the "HIGH" in 5Hz;

### Set up procedure:

- Turn the gain control all the way down;
- Disconnect the output cables from the amplifier outputs;
- Turn off all processing (bass, treble, loudness, EQ, etc.);
- Set the audio player volume to 3/4 of full volume;
- Use a 60 Hz sine wave;
- Increase the gain control until the "CLIP" LED starts blinking;
- Return the gain to the limit where the "CLIP" LED stops blinking and remains off;
- Once you have adjusted the amplifier to the correct voltage output, turn off the source unit and reconnect the speaker(s).

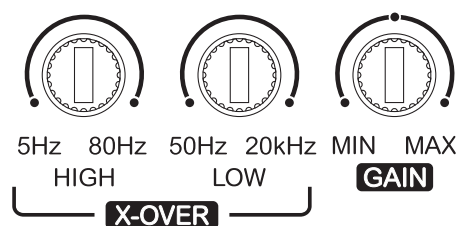

Download the tracks for set up in <https://soundigitalusa.com/tracks-for-set-up/>

## Using Bass Boost

The Amplifier Bass Boost setting enables the user to boost the sound intensity at low frequencies of the sound system, where boost intensity can be adjusted.

This is a semi-parametric equalizer type circuit with "Q" value for the fixed filter, with an intensity boost adjustment from 0 to +12dB (16 times), and a central frequency adjustment of the filter in 50Hz, making it versatile for several types of sound systems.

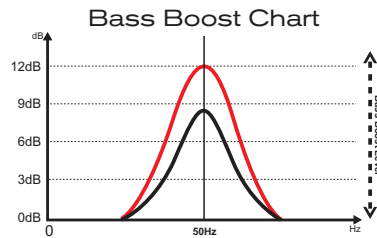

## How to adjust Bass Boost

Reproduce your favorite song and set the boost intensity between 0dB and +12dB at the variable control level according your preference.



0 +12dB  
BASS  
BOOST  
LEVEL

## How to adjust the Crossovers

The use of the two associated filters can form a bandpass filter, as in the figure below, where the point "A" is defined in the "HIGH" crossover and the point "B" is defined in the "LOW" crossover.

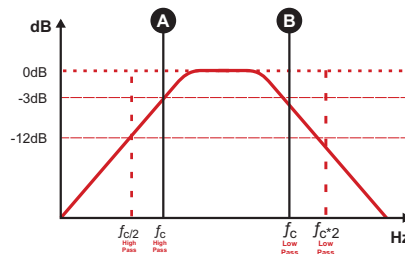
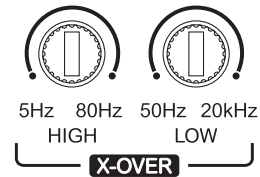

To set the "HIGH" variable control between 5Hz and 80Hz ("A") where you want to perform the high pass cut filter;

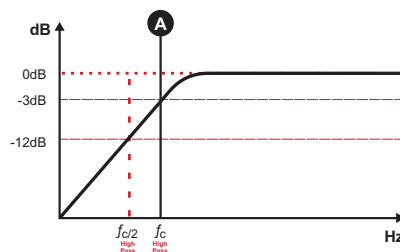

Set in the "LOW" variable control between 50Hz and 20kHz ("B") where you want to perform the low pass cut filter.

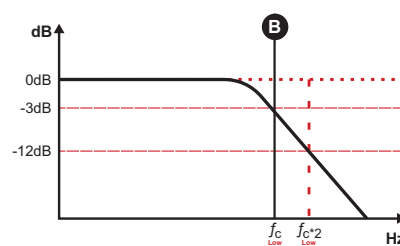

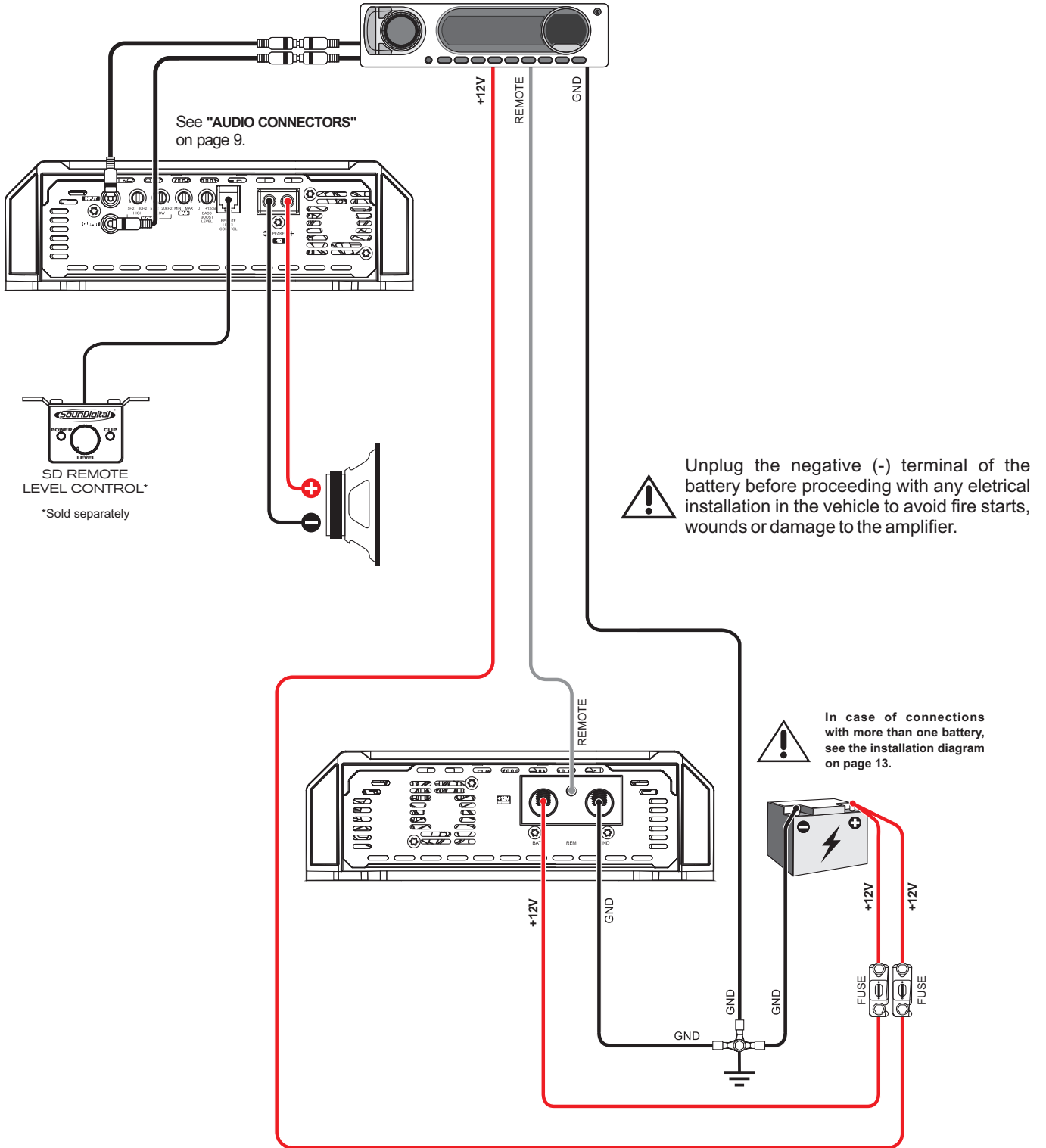

Model	Minimum impedance
8000.1 EVO4.0 1Ω	1Ω
8000.1 EVO4.0 2Ω	2Ω

When necessary the association of one or more battery banks to supply the necessary current to the amplifier, it is recommended to use batteries of the same brand, model, and if possible the same manufacturing lot so that the system has the maximum performance.

For an ideal energy performance, we recommend that all batteries be connected to positive and negative busbars and the busbars connected to the amplifier, as shown in the diagram below:

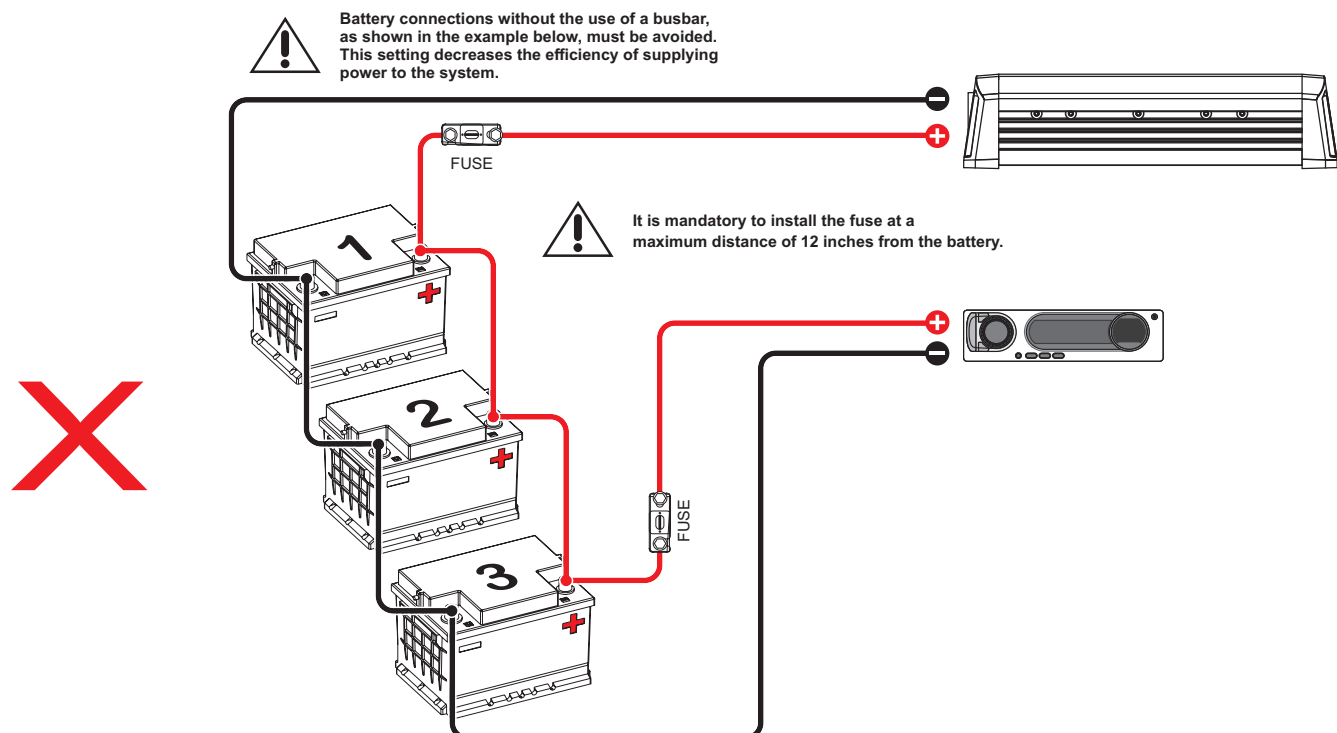
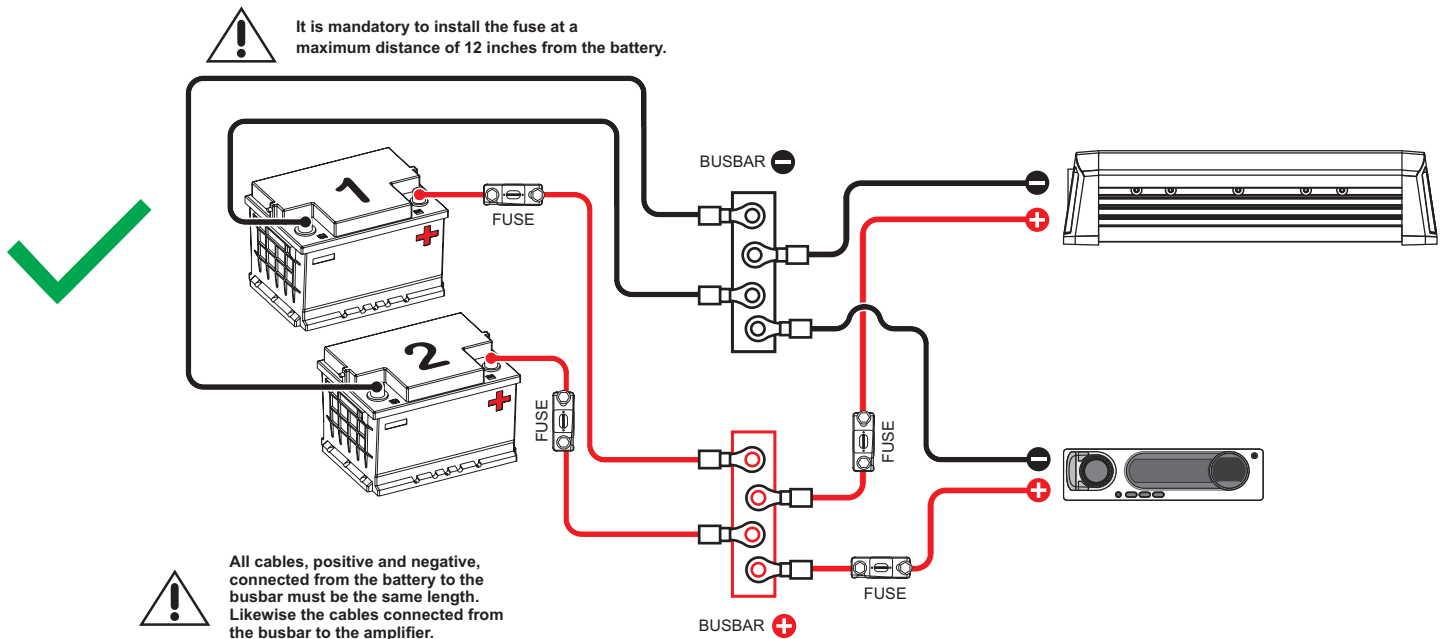

PARAMETERS	8000.1 EVO <sub>4.0</sub> 1Ω	8000.1 EVO <sub>4.0</sub> 2Ω
Power RMS @ 4Ω**	3485W	5280W
Power RMS @ 2Ω**	5280W	8000W
Power RMS @ 1Ω**	8000W	N/A
Frequency Response (-3dB)	5Hz ~ 20kHz	5Hz ~ 20kHz
High Pass filter (12dB/octave)	5Hz ~ 80Hz	5Hz ~ 80Hz
Low Pass filter (12dB/octave)	50Hz - 20kHz	50Hz ~20kHz
Bass Boost	0dB ~ 12dB @ 50Hz	0dB ~ 12dB @ 50Hz
Operating Voltage	8V ~ 16V	8V ~ 16V
SNR	82dB	82dB
Minimum input Sensitivity (RCA)	200mV	200mV
Input Sensitivity (High Level input)	N/A	N/A
Current Draw (music)	402A	402A
Current Draw (max.)	804A	804A
Total Efficiency	79%	79%
Damping Factor (@100Hz nominal impedance)	>1000	>1000
Power Cable	70mm <sup>2</sup> (00 AWG)	70mm <sup>2</sup> (00 AWG)
Speaker Cable	10mm <sup>2</sup> (7 AWG)	10mm <sup>2</sup> (7 AWG)
Remote Cable	1.5mm <sup>2</sup> (15 AWG)	1.5mm <sup>2</sup> (15 AWG)
Recommended Fuse* (music)	500A	500A
Recommended battery (minimum)	400Ah	400Ah

\*It is mandatory to install the fuse at a maximum distance of 12 inches from the battery.

\*\*Power at 12.6V @ 60Hz with a maximum THD of 1%.



**\*\*POWER RATING ACCORDING TO CTA-2006 INDUSTRY STANDARDS.**

## DIMENSIONAL DATA

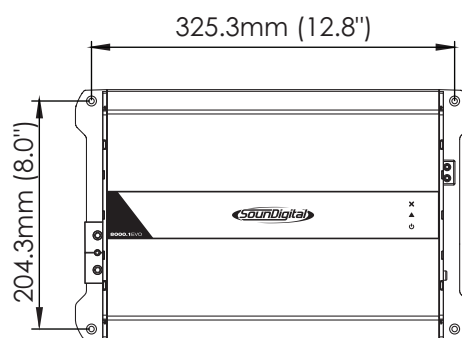
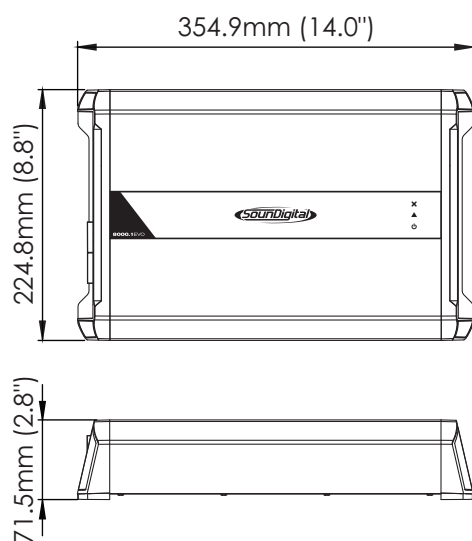

Net Weight	4.43 kg (9.76 lb)
Gross Weight	4.80 kg (10.58 lb)

## ADDITIONAL INFORMATION

The values presented are based on measurements performed in SoundDigital's laboratories. All the equipment used in the assays, tests, measurements and gauging of the technical parameters of SoundDigital products were calibrated in certified laboratories, thus ensuring the performance and standard of excellence of the developed products.

The Manufacturing Process may present variations, and the electronic components may also present changes in values in relation to their nominal parameters. Thus, causing small differences between measurements taken. Small variations in the values presented and divulged by SoundDigital are recognized.



Updates of information made in this document will always be published and made available for consumer consultation, free of charge, on the brand's websites. The user is advised to search for the manual in its latest version when necessary.

The images presented in this document are representative and merely illustrative; therefore, they do not necessarily correspond to the actual product/model.



YOUR MUSIC. **YOUR POWER.**

Document revision code: 1000750012-003/FEB2024



Consumer  
Technology  
Association™



[WWW.SOUNDIGITALUSA.COM](http://WWW.SOUNDIGITALUSA.COM)



[SOUNDIGITALUSA](https://www.facebook.com/SOUNDIGITALUSA)



[SOUNDIGITALUSA](https://www.instagram.com/SOUNDIGITALUSA)